

## Dimension

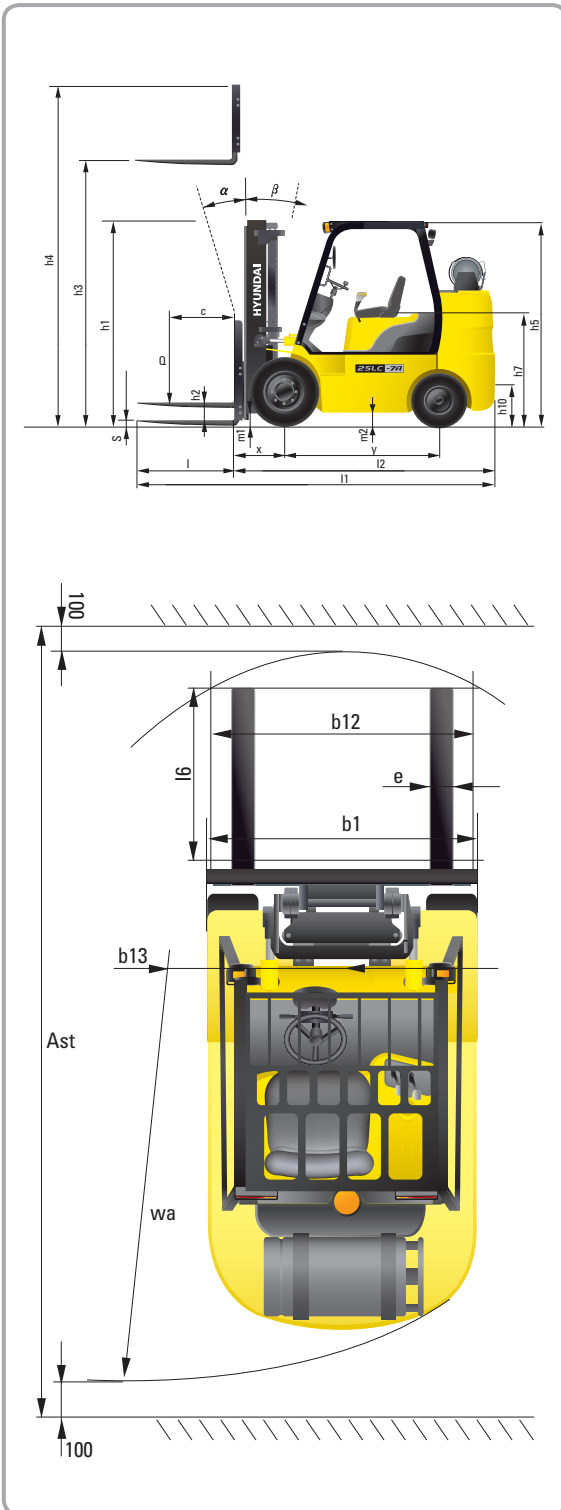

## Specification

Identification				
1.1	Manufacturer	Hyundai	Hyundai	
1.2	Manufacturer's type designation	25LC-7A	30LC-7A	
1.3	Drive: electric (battery or mains), diesel, petrol, fuel gas, manual	LPG	LPG	
1.4	Type of operation: hand, pedestrian, standing, seated, order-picker	seated	seated	
1.5	Load capacity / rated load	Q (lb)	5,000	6,000
1.6	Load center distance	c (in)	24	24
1.8	Load distance, center of drive axle to fork	x (in)	18	18
1.9	Wheelbase	y (in)	56	56
Weights				
2.1	Service weight	lb	8,274	9,352
2.2	Axle loading, loaded front/rear	lb	12,129 / 1,655	14,019 / 1,946
2.3	Axle loading, unloaded front/rear	lb	2,983 / 5,291	3,029 / 6,323
Wheels, Chassis				
3.1	Tires: solid rubber, superplastic, pneumatic, polyurethane	Solid rubber	Solid rubber	
3.2	Tires size, front( width x $\Phi$ )	21 x 7 x 15	21 x 8 x 15	
3.3	Tires size, rear( width x $\Phi$ )	16 x 6 x 10.5	16 x 6 x 10.5	
3.5	Wheels, number front x rear (x=driven wheels)	2 x 2	2 x 2	
3.6	Track width, front	b10 (in)	35	36
3.7	Track width, rear	b11 (in)	35.8	35.8
Basic Dimensions				
4.1	Mast / fork carriage tilt forward / backward( $\alpha$ / $\beta$ )	degrees	6 / 10	6 / 10
4.2	Lowered mast height	h1 (in)	84	84
4.3	Free lift	h2 (in)	4.5	4.5
4.4	Lift height	h3 (in)	130	130
4.5	Extended mast height	h4 (in)	176.6	176.6
4.7	Overhead load guard (cab) height	h5 (in)	82	82
4.8	Seat height / standing height	h7 (in)	41	41
4.12	Coupling height	h10 (in)	8.9	8.9
4.19	Overall length	l1 (in)	132	135
4.20	Length to face of forks	l2 (in)	91	93
4.21	Overall width	b1 (in)	42	44
4.22	Fork dimensions	s / e / l (in)	41.3 x 3.9 x 1.8	41.3 x 4.8 x 1.8
4.23	Fork carriage ISO 2328, class / type A,B	II / A		III / A
4.24	Fork-carriage width	b12 (in)	40.2	40.2
4.31	Ground clearance, loaded, under mast	m1 (in)	3.5	3.5
4.32	Ground clearance, centre of wheelbase	m2 (in)	4.5	4.5
4.33	Aisle width for pallets 1000x1200 crossways	Ast (in)	146	148
4.34	Aisle width for pallets 800x1200 lengthways	Ast (in)	153.9	155.8
4.35	Turning radius	Wa (in)	82	83
4.36	Smallest pivot point distance	b13 (in)	23	23
Performance Data				
5.1	Travel speed, Unloaded	mph	9.9	9.9
5.2	Lift speed, Loaded/Unloaded	fpm	118.5 / 120.1	114.1 / 120.1
5.3	Lowering speed, Loaded/Unloaded	fpm	98.4 / 88.6	98.4 / 88.6
5.5	Drawbar pull, Loaded	lb	5,730	5,655
5.7	Gradient performance, Loaded	%	41.2	34.2
5.10	Service brake		Mechanic / Hydraulic	Mechanic / Hydraulic
Engine				
6.1	Engine manufacturer / type		HMC L4KB	HMC L4KB
6.2	Engine power acc. to ISO 1585	hp	59	59
6.3	Rated speed	1/min	2,300	2,300
6.4	No. of cylinder / cubic capacity	/cm <sup>3</sup>	4 / 2,359	4 / 2,359
Other Details				
8.2	Type of drive control		Power Shift	Power Shift
8.3	Operating pressure	bar	220 / 165	220 / 165
8.4	Oil volume	ℓ	30	30
8.5	Noise	db(A)	80	80



6100 Atlantic Blvd Norcross, GA 30071  
 TEL (678) 823 7777 FAX (678) 823 7778

PLEASE CONTACT



■ Some of the photos may include optional equipment.

HYUNDAI LPG FORKLIFT TRUCKS **Applied Tier 4 Engine**

# 25LC/30LC-7A





■ Some of the photos may include optional equipment.



# NEW criteria of Forklift Trucks

Hyundai introduces a new line of 7A series  
LPG forklift trucks.  
Excellent power and performance make your  
business more profitable.



## OPSS (Operator Presence Sensing System)

Control of mast tilting, lifting and lowering is not possible through operation of the appropriate control when the operator is not in the seated position

# The new master on the job-site!

Smooth running, efficient and ergonomically designed, 25LC/30LC-7A, 25GC/30GC-7A series are made to meet your needs.

## 59hp/ 2,300rpm

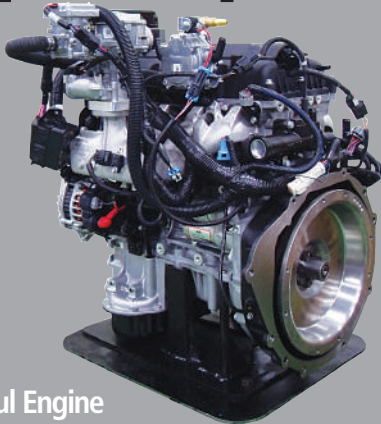

### Powerful Engine HMC L4KB(2.4L) Engine

Market approved quality of HMC L4KB engine ensures incomparable performance, durability and additional value to the machine. Powerful and efficient engine provides excellent fuel economy and excellent torque for improved operation. (EPA/CARB Tier-IV Certified)

### Fast and Stable Performance

Being able to quickly raise and lower the mast, as well as tilt it forward and backward, provides the best operational conditions during unloading. When the truck is fully loaded, mast lowering speed is carefully controlled to ensure safety by the down control valve. Mast, Lift and Tilt Lock System is standard.

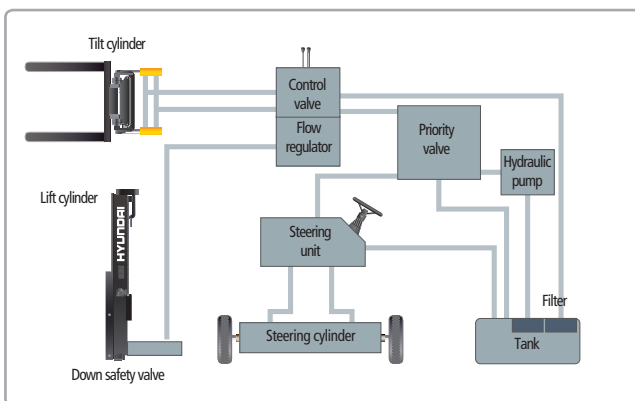
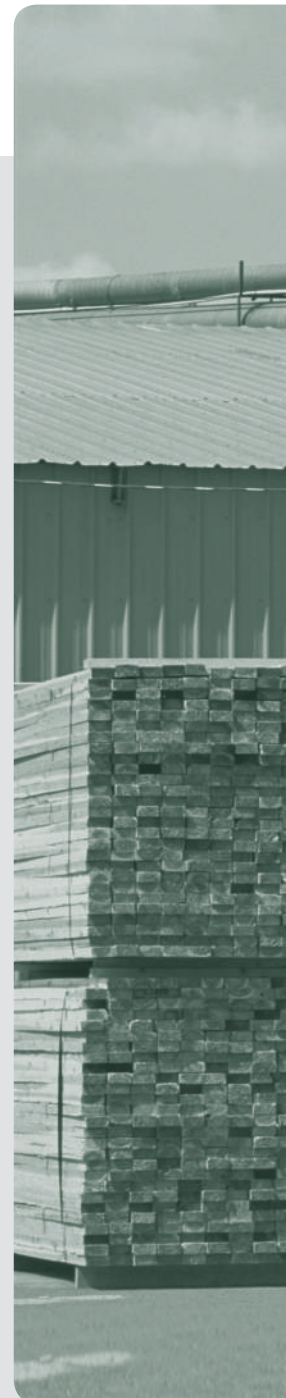

### State-of-the-art Hydraulic System

The latest large-capacity hydraulic system reacts quickly during operation, and a low-noise control valve increases both efficiency and durability.



### Fully Hydrostatic Power Steering

A hydraulic steering system always guarantees smooth and flexible steering, preventing overrun and kick-back.



# High Power Low Noise



■ Some of the photos may include optional equipment.



**Increased Mast Tilting Angle**  
Utilizing the mast tilting angle of 6 degrees forward and 10 degrees backward, the operator can safely and rapidly perform loading and unloading jobs.

### Faster Travel Speed & Better Gradability

The powerful high-output engine provides dynamic acceleration, untiring gradability and optimal travel speed on any tough terrains or slopes.



#### Gradability(Loaded)

25LC-7A : 41.2%  
30LC-7A : 34.2%

#### Travel Speed(Unloaded)

25LC-7A : 9.9mph  
30LC-7A : 9.9mph



# Ergonomic operator friendly compartment design!

A design based on human engineering relieves fatigue and increases operator's efficiency.

## Operator Friendly Gauges and Water-resistant Monitor Panel

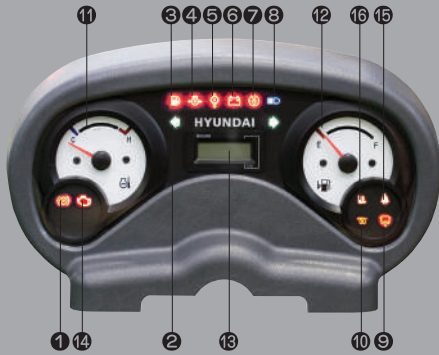

- ① Parking brake lamp
- ② Directional indicators
- ③ Fuel warning lamp
- ④ Engine oil warning lamp
- ⑤ Transmission oil temperature warning lamp
- ⑥ Battery charging warning lamp
- ⑦ Air cleaner filter warning light
- ⑧ Working light indicator
- ⑨ Water separator lamp
- ⑩ Pre-heater indicator
- ⑪ Water temperature gauge
- ⑫ Fuel gauge
- ⑬ Hour meter
- ⑭ Engine check lamp
- ⑮ Seat belt warning
- ⑯ OPS warning



## Full Suspension Seat

An attractive and adjustable seat, based on a human engineering design, provides great comfort, safety and durability.



## New High Visibility for Safe Operation

The operator is able to work with increased safety and accuracy due to a wider view mast.



## Ergonomically Positioned Pedals

Based on human engineering, the accelerator, brake and inching pedals are optimally positioned for convenience while operating the equipment.



## Cup Holder & Console Box

Additional storage spaces are located inside the operating space for operator's convenience.



## Quick Response of Operating Control Levers

Only minimal operator's effort is required for precise, safe and productive control.



**Travel Speed Control System (Option)**

 ← In-Door : Customer Selection

 ← Out Door : Max Vehicle Travel Speed

■ Some of the photos may include optional equipment.



### Adjustable Steering Wheel

Steering wheel with horn button can be adjusted by a lever on the right-hand side for the most comfortable operator position.



### Easy and Safe Shift Lever

A single lever on the left side of the steering column gives the operator fast, easy control of direction. The lever must be in the neutral position before the engine can be started.



### Secondary Horn

Secondary Horn gives access to lights and horn



# Danger-free through high durability!

Safety and durability are priorities in design of the equipment.



## Strong Overhead Guard

The safety overhead guard meets ISO 6055 regulation and protects the operator during hazardous jobs.



## Parking brake

Ratchet type parking brake requires less effort from the operator to set.

## Highly Durable Split Type Drive Axle

The bevel gear set and hub reduction axle smoothly delivers desired torque to the drive wheels.

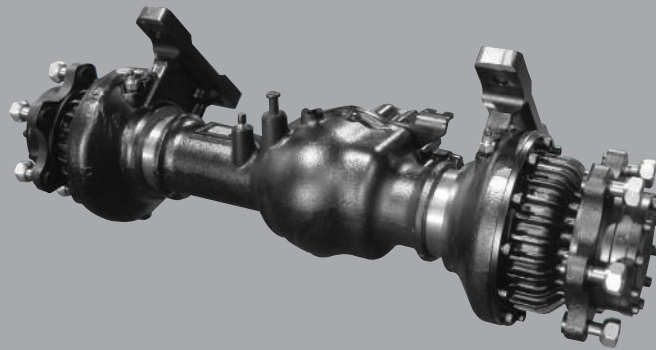

## Large Footboard & Hand Grip

Wide "open" step offers convenience and safety when entering and exiting truck.



## Expansion Bellows

The expansion bellows absorbs vibration and reduces noise generated from the exhaust system and also extends the life cycle of exhaust system.



## Electrically Monitored Air Filter

Air cleaner sensor alerts the operator of a restricted air filter and allows replacement before damage occurs.





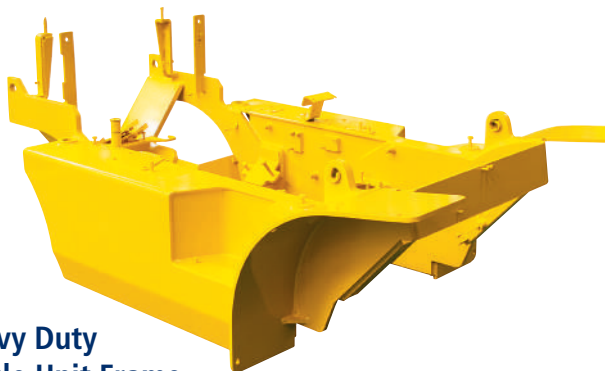

### Heavy Duty Single Unit Frame

Heavy duty single unit type frame, designed on the basis of accurate structural analysis, guarantees durability and safety.



### Bright, Protected Headlights

Bright, Protected head lights are positioned for exceptional visibility.

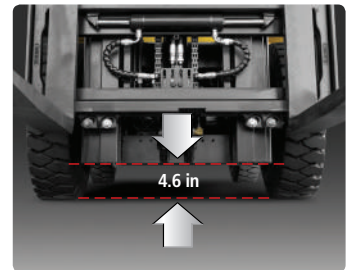

### Ground Clearance

The engine and transmission are assembled horizontally and positioned high in the frame to protect major components during operation on rugged surface.



# Designed for quick and easy service!

An ideal arrangement of component parts ensures easy access and convenience for maintenance.



## Easy Change Air Cleaner

The air filter is readily accessible for cleaning or replacement. (6inch Cyclone Type)



## Fast Service Access for Daily Fluids Check



## Rotational Battery Installation



## One Touch, No Tool Floor Plate



## Removable Side Panels for Ease of Service

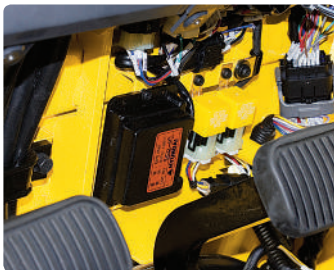

## Improvement in Maintenance of Electric Parts

Various electric parts are centralized in dash board resulting in effortless troubleshooting.

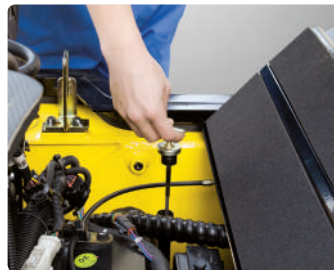

## Easy Maintenance Oil Check

The T/M oil level can be checked easily without any disassembly.



## Brake Fluid Reservoir With Level Switch

When the brake oil level become lower than Min. level, the warning lamp on the clusters comes on.

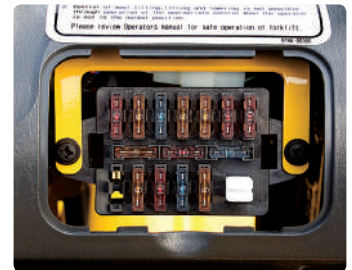

## An Accessible, Compact Fuse Box for Easy Inspection

## Mast Specification

Mast Type	Maximum Fork Height (in)	Overall Height Lowered (in)	Tilt Angle (deg)		Free Lift (in)				Load Capacity w / o Integral Side Shift 24 in LC (lb)		Load Capacity w / Integral Side Shift 24 in LC (lb)		Truck Weight Unload		
					With Backrest		With / o Backrest		Single Tire		Single Tire		Single Tire		
			Fwd	Bwd	25LC-7A	30LC-7A	25LC-7A	30LC-7A	25LC-7A	30LC-7A	25LC-7A	30LC-7A	25LC-7A	30LC-7A	25LC-7A
2-Stage Limited Free Lift	V209	82.3	60.2	10	6	4.5	4.5	4.5	4.5	5000	6000	5000	6000	8088	9148
	V300	118.1	78.1	6	10	4.5	4.5	4.5	4.5	5000	6000	5000	6000	8231	9593
	*V330	129.9	84.0	6	10	4.5	4.5	4.5	4.5	5000	6000	5000	6000	8274	9637
	V350	137.8	87.9	6	10	4.5	4.5	4.5	4.5	5000	6000	5000	6000	8311	9668
	V370	145.7	93.9	6	10	4.5	4.5	4.5	4.5	5000	6000	5000	6000	8360	9715
	V400	157.4	99.8	6	10	4.5	4.5	4.5	4.5	5000	6000	5000	6000	8426	9761
	V430	169.3	105.7	6	10	4.5	4.5	4.5	4.5	5000	6000	4960	5890	8527	9808
	V450	177.2	111.6	6	5	4.5	4.5	4.5	4.5	4960	5890	4900	5840	8589	9854
	V470	185.0	115.5	6	5	4.5	4.5	4.5	4.5	4850	5840	4790	5730	8621	9885
V500	196.9	121.4	6	5	4.5	4.5	4.5	4.5	4790	5730	4740	5620	8669	9932	
3-Stage Full Free Lift	TF370/TS370	145.7	70.3	6	5	23.8	23.8	46.3	43.9	5000	6000	5000	5950	8530	9932
	TF400/TS400	157.4	74.2	6	5	27.8	27.8	50.3	47.8	4960	5890	4900	5780	8579	9980
	TF430/TS430	169.3	78.2	6	5	31.7	31.7	54.2	51.7	4850	5780	4790	5670	8618	10010
	TF450/TS450	177.2	82.1	6	5	35.6	35.6	58.1	55.7	4790	5670	4740	5620	8667	10051
	TF470/TS470	185.0	84.1	6	5	37.6	37.6	60.1	57.6	4740	5620	4680	5560	8697	10078
	TF500/TS500	196.9	87.9	6	5	41.5	41.5	64.1	61.6	4630	5510	4570	5450	8746	10127
	TF550/TS550	216.5	95.9	6	5	49.4	49.4	71.9	69.4	4460	5340	4400	5230	8831	10211
TF600/TS600	236.2	103.7	6	5	57.3	57.3	79.8	77.3	3740	3850	3740	3850	8974	10345	
4-Stage Full Free Lift	QF610	240.7	83.5	3	3	37.0	37.0	59.5	57.0	3280	3680	3170	3480	9446	10470
	QF660	260.4	91.3	3	3	44.9	44.9	67.4	64.9	3090	3480	2980	3280	9578	10600
	QF700	276.2	95.3	3	3	48.8	48.8	71.3	68.9	2910	3060	2800	2910	9647	10668
	QF745	293.9	101.2	3	3	54.7	54.7	77.2	74.8	2270	2470	2180	2290	9746	10770
	QF790	311.6	107.1	3	3	60.6	60.6	83.1	80.7	1460	1520	1370	1410	9969	10990

\* TS-Mast : Wide Visible 3 Stage Full Free Lift Mast with 2 Free Lift Cylinders.

## Load Capacity

25LC-7A

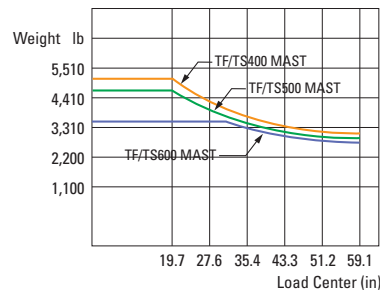
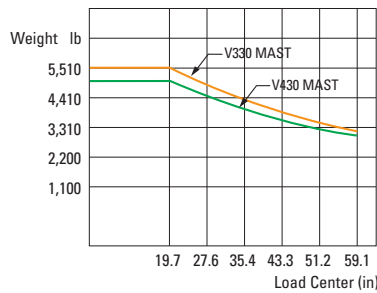

30LC-7A

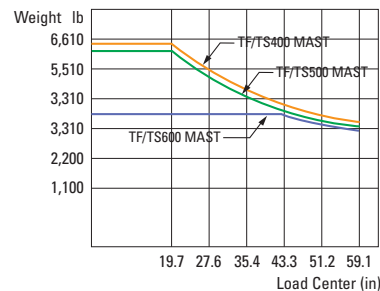
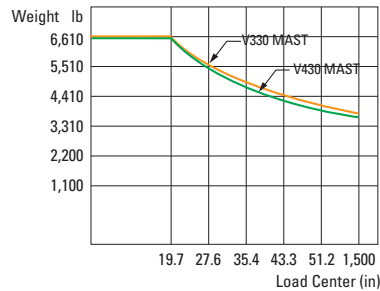

## Optional Items

- **SIDE SHIFT**
- **TILTING** : 6/5°, 3/3°, 10/6°(Bottler Tilt's)
- **M.C.V** : 4-Spool
- **INTEGRAL SIDE SHIFT**
- **TIRE** : Cushion, No-marking
- **ATTACH PIPING** : 3 Spool-piping, 4 Spool-piping
- **FORK** : 35 in, 39 in, 47 in, 53 in, 59 in, 65 in, 71 in
- **SEAT** : Pocket, Arm Rest, Hip Rest, FG 25, 26 Grammer Seat
- **MASTER SWITCH**      • **BEACON LAMP**
- **OVER SHOE** : 51 in, 59 in, 67 in, 71 in
- **LPG CLAMP** : Swing Out, Swing Down
- **HAZARD SWITCH**      • **WORK LAMP**
- 
- **SPEED CONTROL SENSOR**