

10/13/15/18/20BR-9 25/30BR-9

Electric Reach Trucks

MOVING YOU FURTHER

HYUNDAI HEAVY INDUSTRIES



 **HYUNDAI**
CONSTRUCTION EQUIPMENT AMERICAS, INC.

Your satisfaction is **our priority!**

Hyundai introduces a new line of **9-series** battery forklift trucks. The newly designed stand up reach trucks provide every operator comfortable driving, increased productivity and easy maintenance.



■ Some of the photos may include optional equipment.

Compact forklift with proven AC technology

- Maximum performance
- Comfortable operating room
- 3.5 inch LCD color Monitor
- Curve control system
- Load indicator



High Efficiency & Optimal Performance



Direction Lever

The accelerator control provides the operator with precise and smooth directional control.



Electric Power Steering (EPS)

EPS assures effortless steering allowing less fatigue to the operator. Machine performance and battery life are also enhanced.



■ Some of the photos may include optional equipment.

Versatile Reach Stroke

Multi-roller reach assembly provides a smooth, controlled and safe load handling system. Extended reach allows unsurpassed versatility.

High Technology ZAPI Controller

The efficient, almost noiseless, 8khz (high frequency) ZAPI controller provides smooth quiet operation and protection for low & high voltage, overheating and fault recording.



DC-DC Converter

DC-DC converter, satisfied with UL & CE, prevents from short circuit, overload and reverse polarity.

Efficient, smooth running and powerful performance make your work more productive.

10/13/15/18/20BR-9
25/30BR-9



Minimum Turning Radius

Compact design suitable for narrow aisle operation guarantees work efficiency and maximum space utilization.

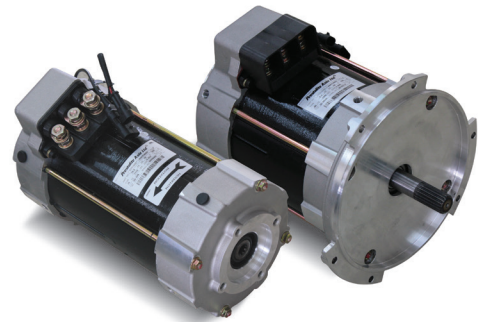

Advanced drive and lift performance with proven durability and low maintenance

The enclosed drive and pump motor with AC technology combine power, high maintenance intervals and excellent durability. The brushless AC motors offer high operator efficiency and very low maintenance cost.

■ Some of the photos may include optional equipment.

Anti roll back system, travel speed and gradeability

Anti Roll-back system offers protection against the machine rolling back on a ramp in combination with exceptional ramp start capabilities.



Max.Gradeability (loaded)		Max.Travel Speed (Unloaded)	
Model	%	Model	mph
10BR-9	21	10BR-9	7.1
13BR-9	19	13BR-9	7.1
15BR-9	27	15BR-9	6.8
18BR-9	25	18BR-9	6.8
20BR-9	23	20BR-9	6.8
25BR-9	15	25BR-9	7.5
30BR-9	13	30BR-9	6.8

Optimized Ergonomics & Advanced Safety



■ Some of the photos may include optional equipment.



Newly Designed Steer Control Handle

A newly designed steering control coupled with our new Electric Power Steering control gives the operator exceptionally smooth and controlled steering in tight spaces.



User Friendly Hydraulic Control Levers

Minimal operator effort is required for precise, safe and productive control. Levers provide easy operation of the hydraulic functions.



Non Slip Floor Mat

A heavy, vibration dampening, non-slip floor mat reduces operator fatigue and allows for increased productivity.

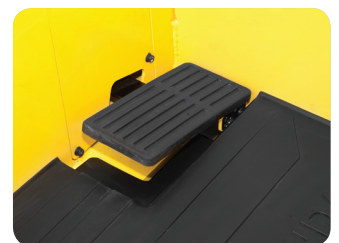

Brake Pedal

Smooth braking is assured by a balanced pedal design.

The safely designed driver's space makes your operating more comfortable.

10/13/15/18/20BR-9
25/30BR-9



■ Some of the photos may include optional equipment.

Excellent visibility for safe operation

Optimized lift cylinder arrangement provides operator with wide open visibility.



Strong Overhead Guard

The safety overhead guard meets EEC and ANSI regulations and protects the operator during hazardous work.



Back Pad

The height of the back pad is adjustable to the operator's optimum comfort level.



Operator's Compartment

A large and safe head cushion pad is positioned for operator's safety and comfort.

Fast and Easy Maintenance

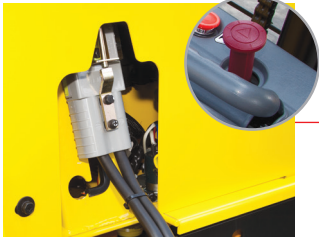

Battery Disconnect Lever & Emergency Switch

Emergency switch is designed to be easily activated in case of emergency.

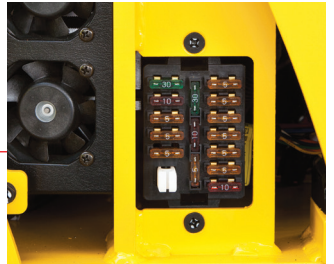

Centralized Fuse Box for Easy Inspection



Disc Brake

Caliper disc brake increases braking force. Maintenance costs are lowered and the brake pad is easy to replace.



EPS (Electric Power Steering) System

EPS assures effortless steering reduces fatigue to the operator, and enhances performance and battery life.

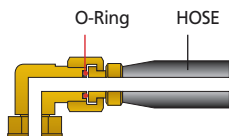

ORFS (O-Ring Face Seal)

ORFS type hose prevents the leaking of hydraulic oil.



Hydraulic Oil Level Gauge

The level gauge is located on the outside of Hydraulic oil tank, which helps to check the OIL level easily and to refill at a proper time.



Easy to Maintain Controller

An ideal arrangement of components ensures high visibility to the instrument panel, and easy access to maintenance information and settings.

10/13/15/18/20BR-9 25/30BR-9

Advanced LCD Monitor



The LCD color monitor with 3.5 inch graphic smart display allows the operator to easily and efficiently control the machine. The monitor provides information about speed & accelerator level, steer angle & travel direction, battery discharge indicator, hour meter & working mode. The standard load indicator displays the load weight in the monitor. The operator can select various performance modes to meet all working conditions. It is available multi-languages (maximum 11) for operator.

H (High) mode **N** (Normal) mode **E** (Economic) mode
Turtle mode



Easy battery replacement

The battery compartment is equipped with a side battery removal assembly for easy removal and replacement.

New 9 Series

Mast Specification (10/13BR-9)

Mast Type	Maximum Fork Height (in)	Overall Height (Lowered) (in)	Overall height (Extended)(in)		Free Lift Height (in)		Tilt Angle (deg) Fwd/Bwd	Load Capacity without side shift at (24in LC)(lb)		Load Capacity with side shift at (24in LC)(lb)		Truck Weight (Unloaded) (lb)		
			With Load Backrest	Without Load Backrest	With Load Backrest	Without Load Backrest		10BR-9		13BR-9		10BR-9	13BR-9	
2-Stage Limited free lift	V250	99	68	139	121	11	11	5 / 5	2,006	2,469	2,006	2,469	4,616	4,636
	V270	107	72	147	129	11	11	5 / 5	2,006	2,469	2,006	2,469	4,647	4,667
	* V300	119	78	159	141	11	11	5 / 5	2,006	2,469	2,006	2,469	4,709	4,729
	V330	131	84	170	153	11	11	5 / 5	2,006	2,469	1,852	2,315	4,742	4,764
	V350	139	88	178	161	11	11	5 / 5	2,006	2,469	1,852	2,315	4,775	4,795
	V370	147	92	186	169	11	11	5 / 5	2,006	2,403	1,852	2,249	4,822	4,841
	V400	158	98	198	180	11	11	5 / 5	1,918	2,315	1,764	2,160	4,890	4,910
	V450	178	112	218	200	11	11	5 / 5	1,808	2,116	1,563	1,962	5,053	5,073
	V500	198	122	237	220	11	11	5 / 5	1,631	1,918	1,477	1,764	5,130	5,152
	V550	218	132	257	240	11	11	5 / 5	1,433	1,720	1,279	1,565	5,210	5,232
3-Stage full free lift	TF370	147	71	186	169	30	48	5 / 5	2,006	2,381	1,852	2,227	4,996	5,016
	TF400	159	75	198	181	34	52	5 / 5	1,918	2,293	1,764	2,138	5,045	5,064
	TF430	171	79	210	193	38	56	5 / 5	1,808	2,205	1,653	2,050	5,093	5,113
	TF450	178	83	218	201	42	60	5 / 5	1,808	2,006	1,653	1,852	5,139	5,159
	TF470	186	85	226	208	44	62	5 / 5	1,720	1,918	1,565	1,764	5,163	5,183
	TF500	198	89	238	220	48	65	5 / 5	1,720	1,808	1,565	1,653	5,214	5,234
	TF550	218	97	257	240	56	73	5 / 5	1,433	1,521	1,279	1,367	5,351	5,370
	TF600	238	105	277	260	64	81	5 / 5	1,235	1,323	1,080	1,168	5,441	5,461
	TE650	257	112	297	279	72	89	5 / 5	1,036	1,124	882	970	5,536	5,556
	TE700	277	120	316	300	80	97	5 / 5	617	705	46	551	5,631	5,650

Mast Specification (15/18BR-9)

Mast Type	Maximum Fork Height (in)	Overall Height (Lowered) (in)	Overall height (Extended)(in)		Free Lift Height (in)		Tilt Angle (deg) Fwd/Bwd	Load Capacity without side shift at (24in LC)(lb)		Load Capacity with side shift at (24in LC)(lb)		Truck Weight (Unloaded) (lb)		
			With Load Backrest	Without Load Backrest	With Load Backrest	Without Load Backrest		15BR-9		18BR-9		15BR-9	18BR-9	
2-Stage Limited free lift	V250	99	68	139	121	11	11	5 / 5	2,976	3,571	2,976	3,571	5,130	5,113
	V270	107	72	147	129	11	11	5 / 5	2,976	3,571	2,976	3,571	5,161	5,143
	* V300	119	78	159	141	11	11	5 / 5	2,976	3,571	2,976	3,571	5,223	5,199
	V330	131	84	170	153	11	11	5 / 5	2,976	3,571	2,822	3,417	5,256	5,238
	V350	139	88	178	161	11	11	5 / 5	2,976	3,571	2,822	3,417	5,289	5,269
	V370	147	92	186	169	11	11	5 / 5	2,976	3,571	2,822	3,417	5,335	5,315
	V400	158	98	198	180	11	11	5 / 5	2,888	3,571	2,734	3,417	5,404	5,386
	V450	178	112	218	200	11	11	5 / 5	2,712	3,417	2,557	3,263	5,567	5,547
	V500	198	122	237	220	11	11	5 / 5	2,513	3,020	2,359	2,866	5,644	5,626
	V550	218	132	257	240	11	11	5 / 5	2,227	2,138	2,072	1,984	5,723	5,706
3-Stage full free lift	TF370	147	71	186	169	30	48	5 / 5	2,998	3,593	2,844	3,439	5,509	5,516
	TF400	159	75	198	181	34	52	5 / 5	2,888	3,505	2,734	3,351	5,558	5,564
	TF430	171	79	210	193	38	56	5 / 5	2,800	3,417	2,646	3,263	5,606	5,613
	TF450	178	83	218	201	42	60	5 / 5	2,712	3,307	2,557	3,153	5,653	5,659
	TF470	186	85	226	208	44	62	5 / 5	2,601	3,219	2,447	3,064	5,677	5,684
	TF500	198	89	238	220	48	65	5 / 5	2,403	3,131	2,249	2,976	5,728	5,734
	TF550	218	97	257	240	56	73	5 / 5	2,138	2,646	1,984	2,491	5,864	5,871
	TF600	238	105	277	260	64	81	5 / 5	1,830	2,138	1,675	1,984	5,955	5,961
	TE650	257	112	297	279	72	89	5 / 5	1,543	1,653	1,389	1,499	6,050	6,056
	TE700	277	120	316	300	80	97	5 / 5	1,124	1,124	970	970	6,144	6,151

* Standard

※ TF-Mast : Wide Visible 3-Stage Full Free Lift Mast with 1 Free Lift Cylinders.

Mast Specification (20BR-9)

Mast Type	Maximum Fork Height (in)	Overall Height (Lowered) (in)	Overall Height(Extended) (in)		Free Lift Height (in)		Tilt Angle (deg) Fwd / Bwd	Load Capacity without side shift at (24in LC)(lb)	Load Capacity with side shift at (24in LC)(lb)	Truck Weight (Unloaded) (lb)	
			With Load Backrest	Without Load Backrest	With Load Backrest	Without Load Backrest					
20BR-9											
2-Stage Limited free lift	V250	100	68	139	121	11	11	5 / 5	3,968	3,968	5,556
	V270	108	72	147	129	11	11	5 / 5	3,968	3,968	5,587
	* V300	119	78	159	141	11	11	5 / 5	3,968	3,968	5,642
	V330	131	84	170	153	11	11	5 / 5	3,968	3,792	5,681
	V350	139	88	178	161	11	11	5 / 5	3,968	3,792	5,713
	V370	147	92	186	169	11	11	5 / 5	3,968	3,792	5,758
	V400	159	98	198	180	11	11	5 / 5	3,968	3,792	5,829
	V450	179	112	218	200	11	11	5 / 5	3,880	3,704	5,990
	V500	198	122	237	220	11	11	5 / 5	3,704	3,527	6,069
	V550	218	132	257	240	11	11	5 / 5	3,505	3,329	6,149
3-Stage full free lift	TF370	147	71	186	169	30	48	5 / 5	3,968	3,792	5,959
	TF400	159	75	198	181	34	52	5 / 5	3,880	3,704	6,010
	TF430	171	79	210	193	38	56	5 / 5	3,792	3,616	6,058
	TF450	179	83	218	201	42	60	5 / 5	3,704	3,527	6,102
	TF470	187	85	226	208	44	62	5 / 5	3,616	3,439	6,127
	TF500	199	89	238	220	48	65	5 / 5	3,505	3,329	6,177
	TF550	218	97	257	240	56	73	5 / 5	3,417	3,241	6,314
	TF600	238	105	277	260	64	81	5 / 5	3,241	3,064	6,404
	TE650	258	112	297	279	72	89	5 / 5	2,646	2,469	6,499
TE700	277	120	316	300	80	97	5 / 5	1,455	1,279	6,594	

* Standard

※ TF-Mast : Wide Visible 3-Stage Full Free Lift Mast with 1 Free Lift Cylinders.

Mast Specification (25/30BR-9)

Mast Type	Maximum Fork Height (in)	Overall Height (Lowered) (in)	Overall Height(Extended) (in)		Free Lift Height (in)		Tilt Angle (deg) Fwd / Bwd	Load Capacity without side shift at (24in LC)(lb)		Load Capacity with side shift at (24in LC)(lb)		Truck Weight (Unloaded) (lb)			
			With Load Backrest	Without Load Backrest	With Load Backrest	Without Load Backrest		25BR-9	30BR-9	25BR-9	30BR-9	25BR-9	30BR-9		
25/30BR-9															
2-Stage Limited free lift	V250	99	70	139	123	125	12	12	5/5	4,960	5,974	4,960	5,974	6,446	7,119
	V270	108	74	147	131	125	12	12	5/5	4,960	5,974	4,960	5,974	6,482	7,154
	* V300	118	80	159	143	144	12	12	5/5	4,960	5,974	4,960	5,974	6,537	7,207
	V330	130	86	170	155	156	12	12	5/5	4,960	5,974	4,784	5,798	6,590	7,262
	V350	138	90	178	162	164	12	12	5/5	4,960	5,974	4,784	5,798	6,625	7,297
	V370	146	95	186	170	172	12	12	5/5	4,960	5,974	4,784	5,798	6,695	7,368
	V400	158	101	198	182	184	12	12	5/5	4,960	5,974	4,784	5,798	6,784	7,456
	V430	169	107	210	194	196	12	12	5/5	4,960	5,974	4,784	5,798	6,909	7,582
	V450	177	113	218	202	203	12	12	5/5	4,894	5,908	4,718	5,732	6,964	7,637
	V470	185	117	226	210	211	12	12	5/5	4,806	5,820	4,630	5,644	7,000	7,672
V500	197	123	237	221	223	12	12	5/5	4,608	5,732	4,431	5,556	7,053	7,725	
3-Stage full free lift	TF370	146	72	190	172		26	46	5/5	4,982	5,974	4,806	5,798	6,953	7,637
	TF400	158	76	202	184		30	50	5/5	4,982	5,974	4,806	5,798	7,008	7,690
	TF430	169	80	214	196		34	54	5/5	4,982	5,974	4,806	5,798	7,064	7,745
	TF450	177	84	222	204		38	58	5/5	4,894	5,974	4,718	5,798	7,114	7,796
	TF470	185	86	229	212		40	60	5/5	4,784	5,820	4,608	5,644	7,145	7,829
	TF500	197	90	245	224		44	64	5/5	4,630	5,732	4,453	5,556	7,198	7,879
	TF550	217	98	261	243		52	71	5/5	4,321	5,247	4,145	5,071	7,394	8,076
	TF600	236	105	281	263		59	79	5/5	4,233	4,563	4,056	4,387	7,500	8,184
	TF650	256	113	300	283		67	87	5/5	3,064	3,197	2,888	3,020	7,613	8,294
	TF700	276	121	320	302		75	95	5/5	2,183	2,293	2,006	2,116	7,718	8,400
TF750	295	127	340	322		81	101	5/5	1,257	1,764	1,080	1,587	7,791	8,472	

* Standard

※ TF-Mast : Wide Visible 3-Stage Full Free Lift Mast with 1 Free Lift Cylinders.

10/13/15/18/20BR-9 25/30BR-9

Load Capacity

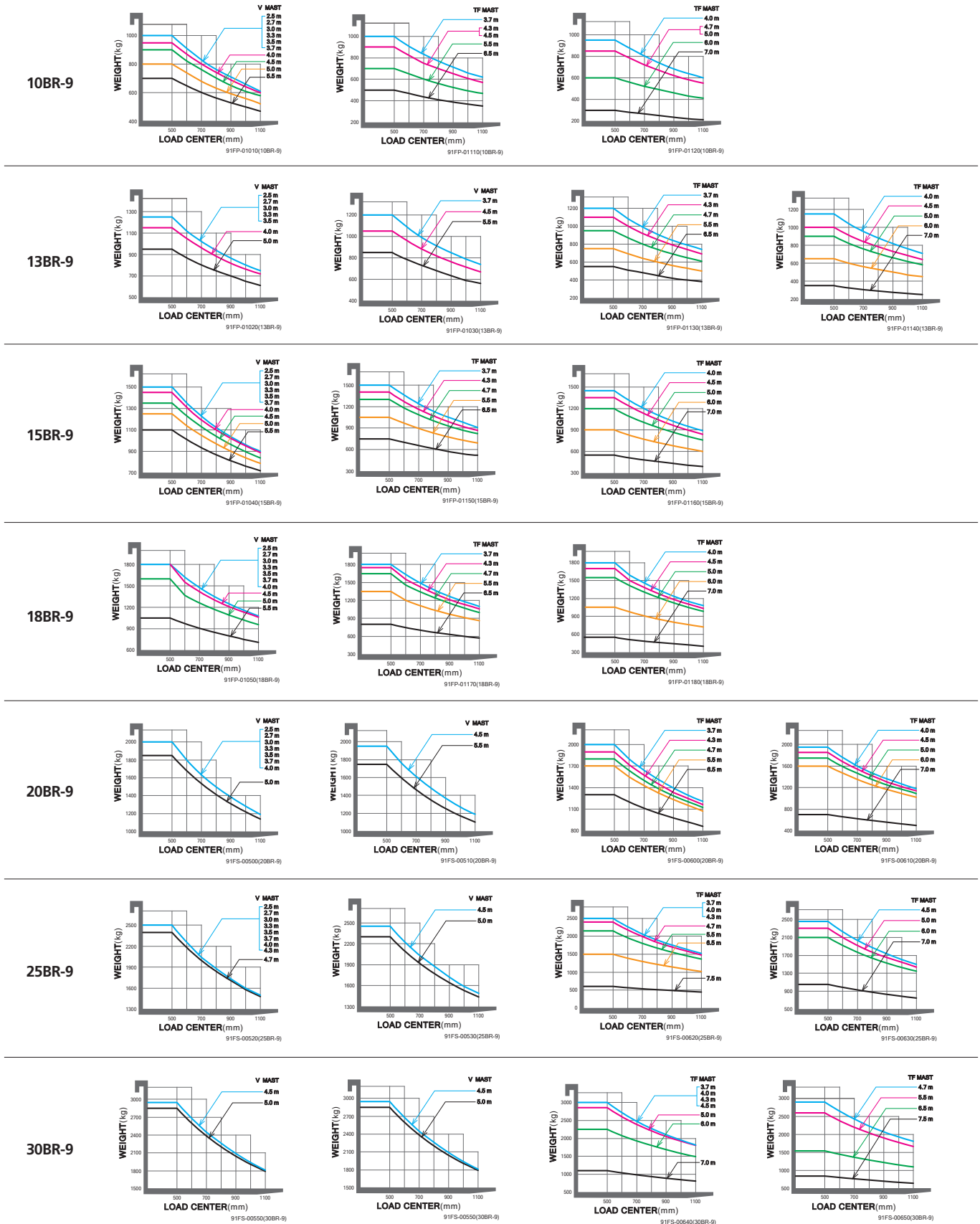

Dimension

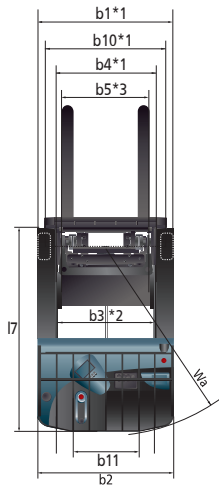
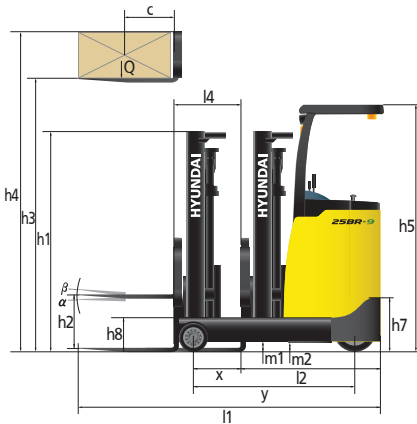

Specification

Identification

		HYUNDAI							
1. 1	Manufacturer								
1. 2	Manufacturer's type designation	10BR-9	13BR-9	15BR-9	18BR-9	20BR-9	25BR-9	30BR-9	
1. 3	Drive : electric(battery or mains) ,diesel, petrol ,fuel gas, manual	electric	electric	electric	electric	electric	electric	electric	
1. 4	Type of operation : hand, pedestrian, standing, seated, order - picker	standing	standing	standing	standing	standing	standing	standing	
1. 5	Load capacity / rated load	Q lb	2,000	2,500	3,000	3,500	4,000	5,000	6,000
1. 6	Load center distance	c in	24	24	24	24	24	24	24
1. 8	Load distance, center of drive axle to fork	x in	6.1	7.4	11	19	19	24	27
1. 9	Wheelbase	y in	44	45	52	59	59	67	71

Weights

2. 1	Service weight (inc. battery)	lb	4,709	4,729	5,223	5,199	5,642	6,537	7,207
2. 3	Axle loading, Fork retracted, Unloaded (Load end/Drive end)	lb	1,750 / 2,937	1,715 / 2,992	1,773 / 3,274	1,625 / 3,530	1,830 / 3,680	2,048 / 4,356	2,326 / 4,881
2. 4	Axle loading, Fork extended, Loaded (Load end/Drive end)	lb	5,714 / 1,177	6,546 / 917	7,288 / 1,065	8,003 / 1,120	8,863 / 1,056	10,670 / 1,246	12,549 / 1,272
2. 5	Axle loading, Fork retracted, Loaded (Load end/Drive end)	lb	4,647 / 2,244	5,227 / 2,235	5,569 / 2,784	5,620 / 3,503	6,484 / 3,435	7,180 / 4,736	8,746 / 5,077

Wheels, Chassis

3. 1	Tires:solid rubber, polyurethane (Load / Drive / Caster)	P/Ure./Rub./Rub.	P/Ure./Rub./Rub.	P/Ure./Rub./Rub.	P/Ure./Rub./Rub.	P/Ure./Rub./Rub.	P/Ure./Rub./Rub.	P/Ure./Rub./Rub.
3. 2	Tires size, Load(Φ x width)	Φ254 x 100	Φ254 x 100	Φ254 x 100	Φ254 x 100	Φ267 x 114	Φ267 x 114	Φ267 x 135
3. 3	Tires size, Drive(Φ x width)	Φ306 x 127	Φ306 x 127	Φ306 x 145	Φ306 x 145	Φ306 x 145	Φ382 x 142	Φ382 x 142
3. 4	Tires size, Caster(Φ x width)	Φ178 x 73	Φ178 x 73	Φ178 x 73	Φ178 x 73	Φ178 x 73	Φ204 x 76	Φ204 x 76
3. 5	Wheels number : load x drive(driven wheels) x caster	2x1x2	2x1x2	2x1x2	2x1x2	2x1x2	2x1x2	2x1x2
3. 6	Track width, Load end	b10*1(in)	38	38	38	39	42	42
3. 7	Track width, Drive end	b11 in	24	24	24	24	27	27

Basic Dimensions

4. 1	Tilt angle, Mast / fork carriage (forward / backward) degrees	5/5	5/5	5/5	5/5	5/5	5/5	5/5	
4. 2	Lowered mast height	h1 in	78	78	78	78	80	80	
4. 3	Free lift	h2 in	9.1	9.1	9.1	9.1	9.7	9.7	
4. 4	Lift height	h3 in	118	118	118	118	118	118	
4. 5	Extended mast height	h4 in	158	158	158	158	159	159	
4. 7	Overhead load guard (cab) height	h5 in	89	89	89	89	90	90	
4. 8	Step height	h7 in	13	13	13	13	14	14	
4. 9	Overall length (Reach In, With Fork)	l1 in	83	83	86	85	93	95	
4. 10	Length to face of forks (Reach In)	l2 in	47	47	47	49	52	53	
4. 11	Overall width (Load end / Drive end)	b1*1/b2 (in)	42	42	42	42	44/42	47	48/47
4. 12	Fork dimensions(hook type)	s / e /l1 in	35 x 3.9 x 1.4	35 x 3.9 x 1.4	35 x 3.9 x 1.4	35 x 3.9 x 1.4	41 x 3.9 x 1.8	41 x 3.9 x 1.8	
4. 13	Fork carriage ISO 2328, class/type A,B	II/A	II/A	II/A	II/A	II/A	II/A	II/A	
4. 14	Fork-carriage width	b3*2 in	31	31	31	31	30	30	
4. 15	Overall fork width	b5*3 in	29	29	29	29	29	29	
4. 16	Distance between support arms/ loading surface	b4*1 (in)	30	30	30	30	30	33	
4. 17	Reach distance	l4 in	13	14	18	26	26	32	35
4. 18	Ground clearance, loaded, under mast	m1 in	4.2	4.2	4.2	4.2	4.2	5.1	5.1
4. 19	Ground clearance, centre of wheelbase	m2 in	3.5	3.5	3.5	3.0	3.0	3.2	2.9
4. 20	Aisle width for pallets 1000x1200 crossways	Ast in	104	104	108	109	109	114	116
4. 21	Aisle width for pallets 800x1200 lengthways	Ast in	107	107	111	110	111	114	115
4. 22	Turning radius	Wa in	55	57	63	70	70	78	82
4. 23	Length across wheel arms	l7 in	59	60	67	74	74	82	86

Performance Data

5. 1	Travel speed, (loaded / unloaded)	mph	7.1	7.1	6.8	6.8	6.8	7.5	6.8
5. 2	Lift speed (loaded/unloaded)	ft/min	65 / 100	65 / 100	65 / 110	65 / 110	65 / 95	55 / 95	43 / 85
5. 3	Lowering speed (loaded/unloaded)	ft/min	100 / 90	100 / 90	100 / 90	100 / 90	100 / 90	100 / 90	100 / 90
5. 7	Max gradient performance, S2 3min (loaded/unloaded) %		21 / 33	19 / 32	27 / 50	25 / 49	23 / 45	15 / 30	13 / 20
5. 9	Acceleration time, 33 ft over (loaded/ unloaded)		6.5	6.7	5.4	5.6	5.8	5.3	5.4
5. 10	Service brake		DISC	DISC	DISC	DISC	DISC	DISC	DISC

Motor

6. 1	Drive motor, rating S2= 60min	kW	4.5	4.5	6	6	6	6	6
6. 2	Lift motor, rating at S3=15% ((S2 5min))	kW	14	14	14	14	14	14	14
6. 3	Battery acc. to DIN 43531/ 35/ 36 A, B, C,no		no	no	no	no	no	no	no
6. 4	Battery voltage, nominal capacity K5(OPTION)48	V / AH	230 (198)	230 (198)	280 (335)	300 (280,335)	335 (300,365)	335 (300,365)	365
6. 5	Battery weight(min)	lb	838 (816)	838 (816)	1,058 (1,235)	1,102 (1,058, 1,235)	1,235 (1,102)	1,235 (1,102)	1,279
6. 6	Battery dimensions L/W/H	in	39/11/23	39/11/23	39/15/23	39/15/23	39/15/23	39/15/23	39/15/23

Other Details

8. 1	Type of drive control		FET Inverter	FET Inverter	FET Inverter	FET Inverter	FET Inverter	FET Inverter	FET Inverter
8. 2	Operating pressure for attachments	bar	130	130	130	130	130	130	130
8. 3	Oil volume for attachments	l/ min	18	18	18	18	18	24	24

*Specifications are based on information available at time of printing and may change without notice.

*1 : TF Mast applied wide frame (10/13/15/18/20BR-9 : 3.9 in, 25/30BR-9 : 4.7 in extended)

*2 : TF Mast applied wide carriage (25/30BR-9 : 6.9 in extended)

*3 : TF Mast applied wide carriage (25/30BR-9 : 6.3 in extended)

Optional Items

·Fork (in)

10/13/15/18BR-9 : 30 / 33 / 41 / 47 / 53 / 59

20/25BR-9 : 35 / 39 / 47 / 53 / 59 /
65 / 71

30BR-9 (Hook) : 35 / 45 / 39 / 53 / 59 /
65 / 71 / 95

·Sideshift

·Carriage (Shaft type)

·Carriage (Narrow, Hook type)

·Tire

10/13/15/18BR-9

Option 1: All Urethane

Option 2: All Rubber

Option 3: All Non - Marking

Option 4: All Vulkollan

Option 5: Load Urethane Caster, Drive Non - Marking

20/25/30 BR-9

Option 1: All Urethane

Option 2: Load Urethane Caster, Drive Non - Marking

Option 3: All Vulkollan

·Cold Storage

(for -30°C cold working environments)

·M.C.V : 3-Spool (STD), 4-Spool

·Beacon Lamp (AMBER,RED,BLUE)

·Load Indicator

·Rear Work Lamp

·UL : ES

·High Head Guard

·Reverse Steering



6100 Atlantic Blvd Norcross, GA 30071
TEL (678) 823 7777 FAX (678) 823 7778

PLEASE CONTACT