

STANDARD EQUIPMENT

ISO standard cabin ·Cabin ROPS(ISO 3471) FOPS(ISO 3449) TOPS(ISO 12117) ·All-weather steel cab with all-around visibility ·Safety glass windows ·Sliding fold-in front window ·Sliding side window ·Lockable door	·Accessory box ·Centralized monitoring ·Gauges Fuel level gauge Engine coolant temperature gauge ·Warning Quick clamp Engine oil pressure Engine coolant temperature	Preheat Low battery Air cleaner clogging Fuel empty ·Door and locks, one key ·Mechanical suspension seat with seat belt ·Radio / USB Player ·Console box tilting system(LH.) ·One front working lights	·Electric horn ·Battery (1 x 12 V x 80 AH) ·Battery master switch ·Automatic swing brake ·Removable reservoir tank ·Water separator, fuel line ·Mono boom (2.5 m, 8' 2") ·Arm (1.3 m, 4' 3") ·Rubber shoe (300mm, 12") ·Single acting piping (Breaker, etc)	·Double acting piping (Clamshell, etc) ·Auto idle function ·Water proof start key ·Anti theft function ·Emergency stop switch ·Auto travel shift down travel motor
--	---	---	--	---

OPTIONAL EQUIPMENT

ISO standard canopy ·Canopy ROPS(ISO 3471) FOPS(ISO 3449) TOPS(ISO 12117) ·Beacon lamp	·Cabin lamp ·Accumulator, work equipment lowering ·Travel alarm ·Quick coupler	·Tool kit ·Operator suit ·Heater & Defroster ·Lever pattern change valve Steel shoe (300mm, 12")	·Air conditioner ·Long Arm (1.6m) ·Additional CWT (150kg, 330lb) ·RCV with proportional control switch ·Rotating piping	·SLV (safety lock valve)
--	--	--	---	--------------------------

* Standard and optional equipment may vary. Contact your Hyundai dealer for more information. The machine may vary according to International standards.

* The photos may include attachments and optional equipment that are not available in your area.

* Materials and specifications are subject to change without advance notice.

* All imperial measurements rounded off to the nearest pound or inch.

PLEASE CONTACT



6100 Atlantic Blvd Norcross, GA 30071
TEL (678) 823 7777 FAX (678) 823 7778

Robex

35Z-9A

With Tier 4 Final Engine installed

MOVING YOU FURTHER

HYUNDAI HEAVY INDUSTRIES



*Photo may include optional equipment.

 **HYUNDAI**
CONSTRUCTION EQUIPMENT AMERICAS, INC.

PRIDE AT WORK

Hyundai Heavy Industries strives to build state-of-the-art earthmoving equipment to give every operator maximum performance, more precision, versatile machine preferences, and proven quality.

Moving you further !



Robex 35Z-9A

Machine Walk-Around

Rugged Upper and Lower Frame

The upper frame is designed to be heavy duty to absorb high stress load on the job. X-leg center frame and reinforced box section track frame provide exceptional strength and longer service life to withstand tough working conditions.

Engine Technology

The R35Z-9A is powered by a proven and reliable, Tier 4 certified YANMAR 3TNV88F. This engine provides efficient fuel combustion and reduced noise.

Efficient Control System

Control devices are all conveniently located for improved operator comfort and productivity. A safety lever on the left-side console is designed to prevent exiting the cabin while hydraulic controls are live.

Advanced Hydraulic System

The R35Z-9A hydraulic system is precision designed for fast operation with fine control capabilities.

Comfortable and Durable Cabin

The cabin is roomy and ergonomically designed, with reduced sound levels and good visibility. Both canopy and cabin style frames meet international standards TOPS, ROPS, FOPS ensuring operator's safety.

Operator Convenience

The R35Z-9A features a suspension seat, foldable pedals for added space and multiple storage compartments.

The monitoring system includes seven warning indicators, water temperature gauge, fuel gauge and hour meter for productive, convenient operating.

Easy and Simple Maintenance

An adjustable suspension seat, wrist rests, ergonomically designed joysticks and plenty of leg room help to reduce operator fatigue. A array of indicators and gauges are displayed on the monitor which keep the operator aware of machine performance at all times. The monitoring system includes seven warning indicators, water temperature gauge, fuel gauge and hour meter.

Extended Life of Components

The R35Z-9A reduces operating costs over time with long life hydraulic filters, hydraulic oil, shims and bushings.



*Photo may include optional equipment.

PRECISION

Innovative hydraulic system technologies make the 9A series excavator fast, smooth and easy to control.



*Photo may include optional equipment.



Boom Swing

The R35Z-9A's boom swing function is designed for efficient work in congested residential and urban areas. The boom can be offset left or right within an operating range.



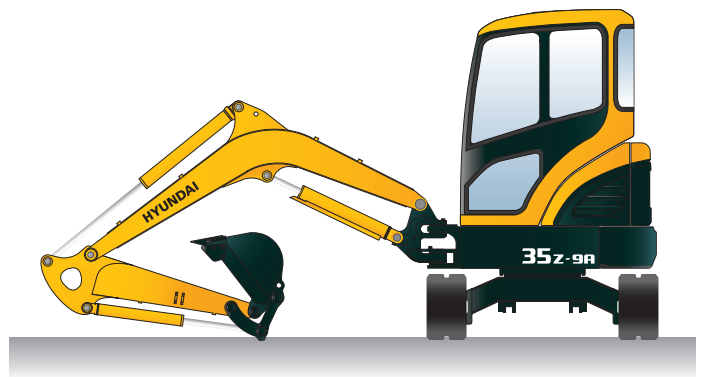
Dozer Blade

Large dozer blade provides added versatility, work efficiency and stability for the job.



Auto Idle Function

Engine speed can be reduced automatically when users do not operate levers so that fuel efficiency can be improved. (and machine noise can be reduced.)



Zero-tail Swing

R35Z-9A's short tail swing radius allows the operator work in confined areas like close to buildings on roadways, and in urban areas. This compact radius design provides easy and efficient operation in any limited space work environment.



Lever Pattern Change Valve (Option)

Joystick control patterns can be changed through an optional pattern change valve positioned for easy access.



Auto Shift Traveling System

During high-speed traveling, travel motor speed decreases automatically when subjected to heavy load, and resumes when the load reduces.

PERFORMANCE

9A series is designed for maximum performance to keep the operator working productively.



*Photo may include optional equipment.



Cylinder Covers

Standard boom and dozer cylinder covers provide added protection.

SLV (Safety Lock Valve)

SLV prevent the load from slipping or dropping due to hose failure.



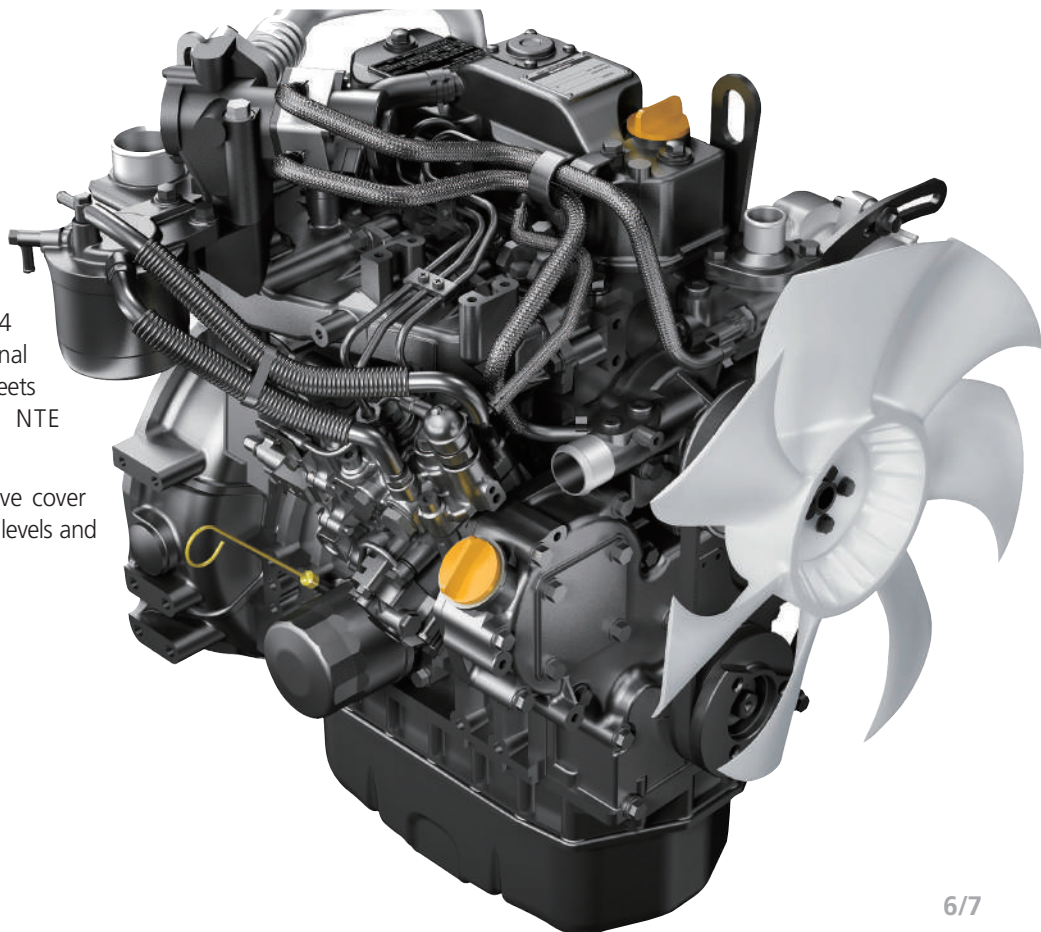
Structure Strength

The R35Z-9A cabin structure has been fitted with stronger but slimmer tubing for added safety and improved visibility. Low-stress, high strength steel is integrally welded to form a stronger, more durable upper and lower frame. Structural integrity was tested by way of FEM (Finite Elements Method) analysis and long-term durability tests.

YANMAR 3TNV88F

Emissions: The most compact multi-cylinder liquid cooled industrial diesel engines comply with EPA Tier 4 Emission regulations without additional After Treatment Tools. This engine meets standards over the NRTC and NTE requirements.

Lower Noise Level: The half-float valve cover and MoS2 coated piston reduce noise levels and vibration.



PREFERENCE

Operating a 9A series is unique to every operator. Operators can fully customize their work environment and operating preferences to fit their individual needs.



*Photo may include optional equipment.



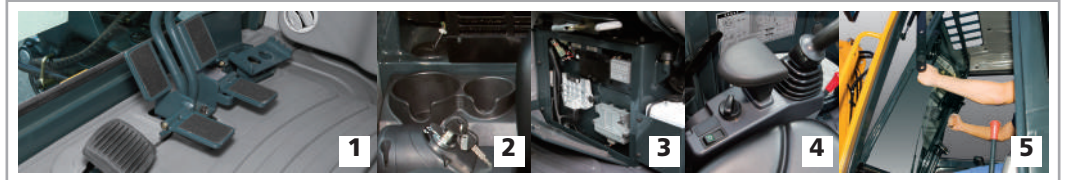
Monitor

The monitoring system of the R35Z-9A provides the operator with machine status information, including: engine oil pressure lamp, battery charge lamp, engine coolant temperature and a fuel gauge.

Comfortable Operating Cabin

In a 9A series cabin, you can easily adjust the seat and wrist rests settings to best suit your preferred operating condition.

1. All pedals are foldable for additional floor space. Foot rest, attachment pedal, left and right travel pedals and boom swing pedal are arranged for convenient access.
2. Two cup holders are integrated into the right console for large and small drink storage.
3. An additional storage box with key lock is accessible under the operator's seat.
4. Adjustable wrist rests provide additional comfort.
5. A sliding fold-in front window is easily opened and safely stored in an open position to improve ventilation and visibility.(Cabin type only)



Reduced Stress

An operator's work environment should be stress free. Hyundai's R35Z-9A compact excavator is designed for comfort, reduced sound and plenty of space to reduce stress on the operator.

Operator Comfort

The left and right control levers are ergonomically located for convenient access. A safety lock system is designed to prevent exiting the cabin while hydraulic controls are live. When the safety lever and left side console are positioned upright, hydraulic functions are disengaged.



A tiltable left-side console make the operator easier to enter and exit the cab.

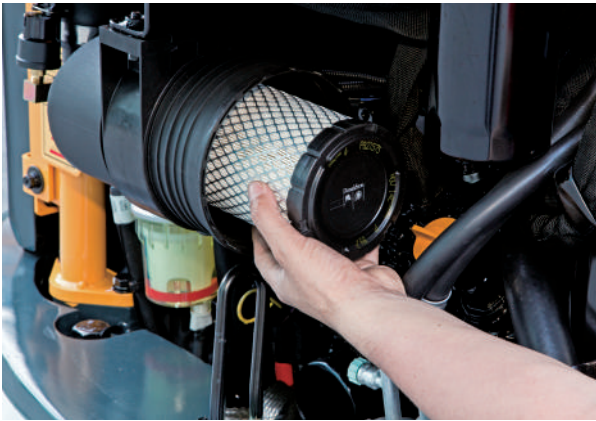


PROFITABILITY

9A series is designed to maximize profitability through improved efficiencies, enhanced service features and longer life components.

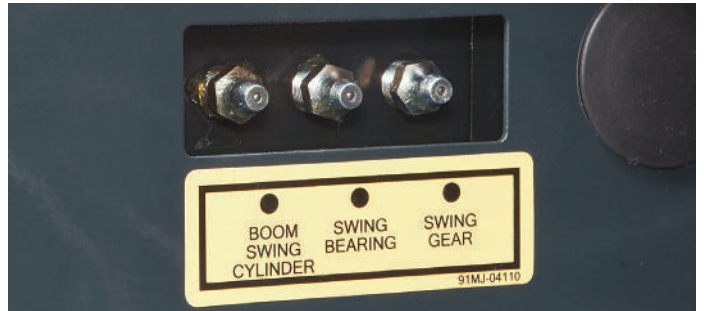


*Photo may include optional equipment.



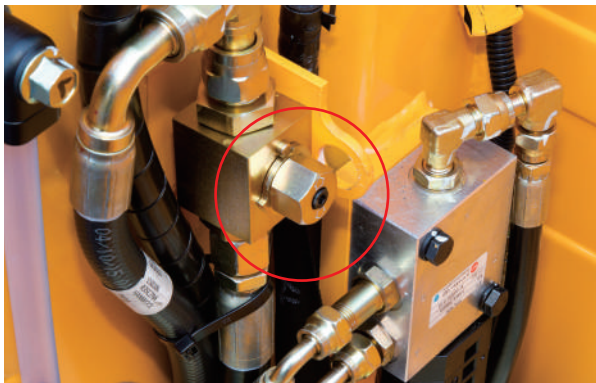
Easy Change Air Cleaner

The R35Z-9A is equipped with a durable plastic air cleaner designed for easy maintenance.



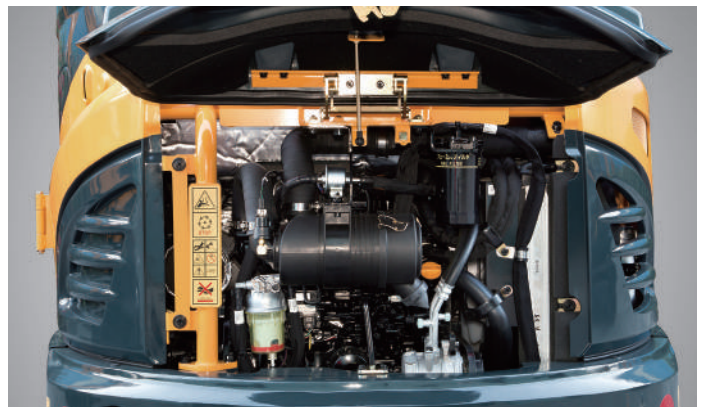
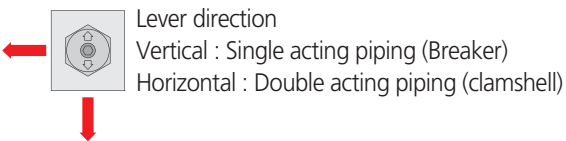
Centralized Grease Fittings

A centralized lubrication bank is available for faster, easier service and maintenance.



Selector Valve for Single or Double Acting Piping

Double Acting Pipe located on front of the Fuel Tank for easy to access and control.



Easy Access

The R35Z-9A was built with accessibility in mind. All doors, covers and hoods were built for complete open access. Regular service and maintenance is easy and convenient with the R35Z-9A.



Proportional Auxiliary Hydraulic System

- Opt: Proportional Control Switch for better speed control
- Enlarge the Operation Convenience



Long-Life Components

9A series excavators were designed with bushings designed for long-life lube intervals (250 hrs) & polymer shims (wear resistant, noise reducing), long-life hydraulic filters (1,000hrs), long-life hydraulic oil (5,000hrs), more efficient cooling systems and integrated preheating systems which extend service intervals, minimize operating costs and reduce machine down time.

Specifications

ENGINE

Model	Yanmar 3TNV88F		
Type	Water cooled, 4 cycle Diesel, 3-cylinders in line, direct injection, low noise		
Rated flywheel horse power			
SAE	J1995 (gross)	24.4 HP (18.2kW) at 2,200rpm	
	J1349 (net)	23.7 HP (17.7kW) at 2,200rpm	
DIN	627 1/1 (gross)	24.7 PS (18.2kW) at 2,200rpm	
	627 1/1 (net)	24 PS (17.7kW) at 2,200rpm	
Max. torque	9.1 kgf-m(79 lbf-ft) at 1,320 rpm		
Bore x stroke	88mm x 90mm (3.5" x 3.5")		
Piston displacement	1,642cc (100 in ³)		
Batteries	12V - 80AH		
Starting motor	12V - 2.3kW		
Alternator	12V - 55A		

HYDRAULIC SYSTEM

Main pumps	
Type	Variable displacement piston pumps
Rated flow	2 x 37.4 + 23.1 + 9.9 L/min
Sub-pump for pilot circuit	Gear pump
Hydraulic motors	
Travel	Two speed axial piston motor with counter balance valve and parking brake
Swing	Axial piston motor with automatic brake
Relief valve setting	
Implement circuits	230 Kg/cm ² (3,270 psi)
Travel circuit	230 Kg/cm ² (3,270 psi)
Swing circuit	200 Kg/cm ² (2,840 psi)
Pilot circuit	30 Kg/cm ² (430 psi)
Service valve	Installed

HYDRAULIC CYLINDER

No. of cylinder - bore x stroke	
Boom	85 x 540 mm (3.3" x 21.3")
Arm	80 x 585 mm (3.1" x 23.0")
Bucket	70 X 510 mm (2.8" x 20.1")
Boom swing	80 X 400 mm (3.1" x 15.7")
Dozer blade	95 X 152 mm (3.7" x 6.0")

NOISE LEVEL(CAB)

Noise Levels (dynamic value)	
LwA	94dB
LpA	75dB

COOLANT & LUBRICANT CAPACITY

(refilling)	liter	US gal	UK gal
Fuel tank	40	10.6	8.8
Engine coolant	5.5	1.5	1.2
Engine oil	6.7	1.77	1.5
Hydraulic tank	37	9.8	8.1

TRAVEL LEVERS

Traveling and steering : Two levers with pedals.

CONTROL LEVERS

Type	
Pilot control	Two joysticks with one safety lever (LH): Swing and arm, (RH): Boom and bucket with horn (ISO)
Engine throttle	Electronical, Accel dial type

SWING SYSTEM

Swing motor	Axial piston motor
Swing reduction	Planetary gear reduction
Swing circuit lubrication	Grease - bathed
Swing brake	Wet disc
Swing speed	9.5 rpm

DRIVES & BRAKES

Max. travel speed(high) / (low)	4.2km / 2.5km (2.6mph) / (1.6mph)
Maximum traction force	3.1ton
Maximum gradeability	30°
Parking brake	Wet disc

DIGGING FORCE(ISO)

	1.3m Arm	1.6m Arm
Bucket	3,130 kgf	3,150 kgf
	30.7 kN	30.9kN
	6,900 lbf	6,945 lbf
Arm	1,990 kgf	1,720 kgf
	19.5 kN	16.9 kN
	4,390 lbf	3,790 lbf

WEIGHT(APPROXIMATE)

Operating weight, including 2,500 mm (8' 2") boom, 1,300 mm (4' 3") arm, SAE heaped 0.11 m³ (0.14 yd³) excavator bucket, lubricant, coolant, full fuel tank, hydraulic tank and the standard equipment.

Shoe Width		Rubber 300mm (12")	Steel 300mm (12")
Operating Weight	Cabin	3,690 Kg (8,140lb)	3,790 Kg (8,360lb)
	Canopy	3,550 Kg (7,800lb)	3,650 Kg (8,050lb)
Ground Pressure	Cabin	0.34 kg/cm ² (4.83psi)	0.35 kg/cm ² (4.98psi)
	Canopy	0.33 kg/cm ² (4.69psi)	0.33 kg/cm ² (4.69psi)

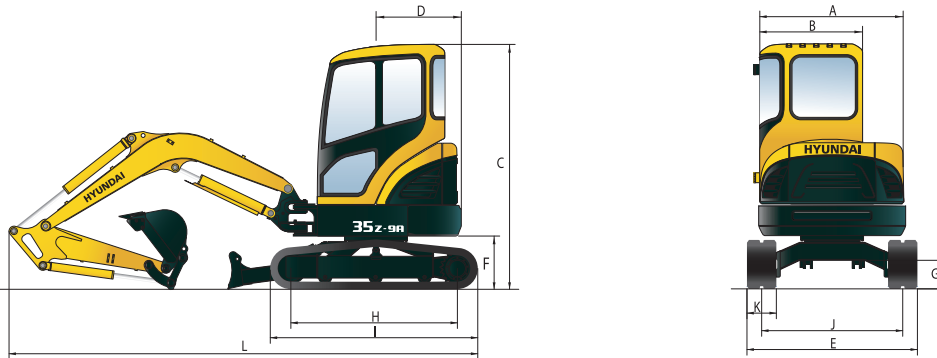
UNDERCARRIAGE

X-leg type center frame is integrally welded with reinforced box-section track frames. The undercarriage includes lubricated rollers, track adjusters with shock absorbing springs and sprockets, and rubber shoes.

Center frame	X-leg type
Track frame	Pentagonal box type
No. of carrier roller on each side	1
No. of track roller on each side	4

Dimensions & Working Range

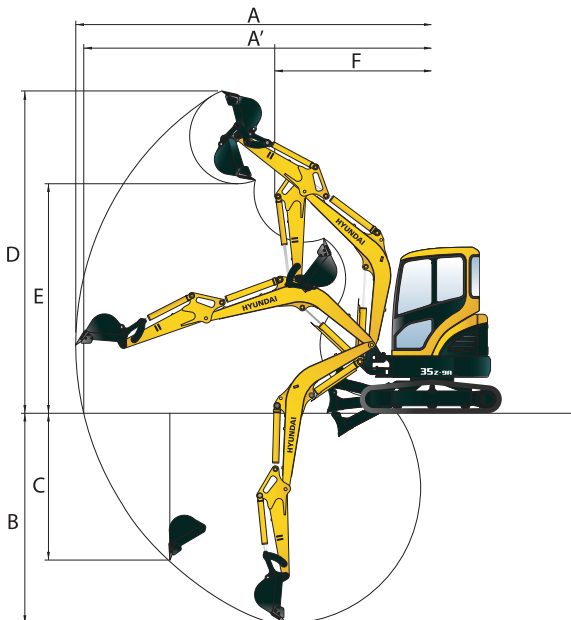
R35Z-9A DIMENSIONS



		mm (ft-in)				
A	Overall width of upper structure	1,500 (4' 11")	G Ground clearance	290 (0' 11")		
B	Overall width of cab	1,050 (3' 5")	H	Tumbler distance	1,700 (5' 7")	
C	Overall height of cab	2,500 (8' 2")	I	Track length	2,130 (7' 10")	
D	Tail swing radius	870 (2' 10")	J	Track gauge	1,440 (4' 9")	
E	Overall width	1,740 (5' 9")	K	Track shoe width	300 (1' 0")	
F	Clearance under counterweight	540 (1' 9")	L	Overall length	1,300Arm 1,600Arm	4,790 (15' 9") 4,815 (15' 10")

R35Z-9A WORKING RANGE

mm (ft-in)













Boom length	2,500 (8' 2")	
Arm length	1,300 (4' 3")	1,600 (5' 3")
A Max. digging reach	5,315 (17' 5")	5,605 (18' 5")
A' Max. digging reach at ground	5,200 (17' 1")	5,495 (18' 0")
B Max. digging depth	3,135 (10' 3")	3,440 (11' 3")
C Max. vertical wall digging depth	2,190 (7' 2")	2,565 (8' 5")
D Max. digging height	4,810 (15' 9")	5,010 (16' 5")
E Max. dumping height	3,425 (11' 3")	3,615 (11' 10")
F Min. swing radius	2,350 (7' 9")	2,330 (7' 8")

Lifting capacity











R35Z-9A

 Rating over-front  Rating over-side or 360 degree

Boom : 2.50 m (8' 2") / Arm : 1.30 m (4' 3") / Bucket : 0.11 m³ SAE heaped / Dozer Down : 300mm(12") Rubber track Canopy Type W/O ADD CWT

Load point height m(ft)		Load radius								At max. reach		
		1.0 m(5 ft)		2.0 m(5 ft)		3.0 m(10 ft)		4.0 m(15 ft)		Capacity		Reach
												m (ft)
4.0 m	kg									*540	*540	3.94
15 ft	lb									*1190	*1190	(12.9)
3.0 m	kg							*600	510	*540	390	4.74
10 ft	lb							*1320	1120	*1190	860	(15.6)
2.0 m	kg					*780	*780	*650	500	*560	330	5.11
5 ft	lb					*1720	*1720	*1430	1100	*1230	730	(16.8)
1.0 m	kg					*1100	750	*760	470	*580	310	5.18
5 ft	lb					*2430	1650	*1680	1040	*1280	680	(17.0)
Ground	kg			*1730	1390	*1290	710	*840	450	*600	330	4.98
Line	lb			*3810	3060	*2840	1570	*1850	990	*1320	730	(16.3)
-1.0 m	kg	*2100	*2100	*2210	1410	*1240	700	*780	450	*600	400	4.45
-5 ft	lb	*4630	*4630	*4870	3110	*2730	1540	*1720	990	*1320	880	(14.6)
-2.0 m	kg			*1520	1450	*860	730					
-5 ft	lb			*3350	3200	*1900	1610					

Boom : 2.50 m (8' 2") / Arm : 1.30 m (4' 3") / Bucket : 0.11 m³ SAE heaped / Dozer Up : 300mm(12") Rubber track Canopy Type W/O ADD CWT

Load point height m(ft)		Load radius								At max. reach		
		1.0 m(5 ft)		2.0 m(5 ft)		3.0 m(10 ft)		4.0 m(15 ft)		Capacity		Reach
												m (ft)
4.0 m	kg									*540	530	3.94
15 ft	lb									*1190	1170	(12.9)
3.0 m	kg							540	490	410	370	4.74
10 ft	lb							1190	1080	900	820	(15.6)
2.0 m	kg					*780	*780	520	480	340	310	5.11
5 ft	lb					*1720	*1720	1150	1060	750	680	(16.8)
1.0 m	kg					800	720	500	450	330	300	5.18
5 ft	lb					1760	1590	1100	990	730	660	(17.0)
Ground	kg			1510	1330	750	680	480	430	340	310	4.98
Line	lb			3330	2930	1650	1500	1060	950	750	680	(16.3)
-1.0 m	kg	*2100	*2100	1520	1340	750	670	480	430	420	380	4.45
-5 ft	lb	*4630	*4630	3350	2950	1650	1480	1060	950	930	840	(14.6)
-2.0 m	kg			*1520	1380	770	700					
-5 ft	lb			*3350	3040	1700	1540					











- Lifting capacity is based on SAE J1097, ISO 10567.
- Lifting capacity of the Robex Series does not exceed 75% of the tipping load with the machine on firm, level ground or 87% of full hydraulic capacity.
- The load point is a hook located (standard equipment) on the back of the bucket.
- (*) indicates the load limited by hydraulic capacity.

Lifting capacity











R35Z-9A

 Rating over-front  Rating over-side or 360 degree

Boom : 2.50 m (8' 2") / Arm : 1.60 m (5' 3") / Bucket : 0.11 m³ SAE heaped / Dozer Down : 300mm(12") Rubber track Canopy Type W/O ADD CWT

Load point height m(ft)		Load radius								At max. reach		
		1.0 m(5 ft)		2.0 m(5 ft)		3.0 m(10 ft)		4.0 m(15 ft)		Capacity		Reach
												m (ft)
4.0 m	kg									*480	460	4.35
15 ft	lb									*1060	1010	(14.3)
3.0 m	kg							*510	*510	*490	340	5.06
10 ft	lb							*1120	*1120	*1080	750	(16.6)
2.0 m	kg							*580	500	*510	290	5.40
5 ft	lb							*1280	1100	*1120	640	(17.7)
1.0 m	kg			*1940	1460	*1000	760	*710	470	*530	280	5.47
5 ft	lb			*4280	3220	*2200	1680	*1570	1040	*1170	620	(17.9)
Ground	kg			*1710	1380	*1240	710	*810	450	*550	290	5.28
Line	lb			*3770	3040	*2730	1570	*1790	990	*1210	640	(17.3)
-1.0 m	kg	*1740	*1740	*2380	1380	*1270	690	*810	440	*560	340	4.80
-5 ft	lb	*3840	*3840	*5250	3040	*2800	1520	*1790	970	*1230	750	(15.7)
-2.0 m	kg	*2470	*2470	*1820	1410	*1020	710					
-5 ft	lb	*5450	*5450	*4010	3110	*2250	1570					

Boom : 2.50 m (8' 2") / Arm : 1.60 m (5' 3") / Bucket : 0.11 m³ SAE heaped / Dozer Up : 300mm(12") Rubber track Canopy Type W/O ADD CWT

Load point height m(ft)		Load radius								At max. reach		
		1.0 m(5 ft)		2.0 m(5 ft)		3.0 m(10 ft)		4.0 m(15 ft)		Capacity		Reach
												m (ft)
4.0 m	kg									*480	450	4.35
15 ft	lb									*1060	990	(14.3)
3.0 m	kg							*510	500	360	330	5.06
10 ft	lb							*1120	1100	790	730	(16.6)
2.0 m	kg							530	480	310	280	5.40
5 ft	lb							1170	1060	680	620	(17.7)
1.0 m	kg			1580	1400	810	730	500	460	290	270	5.47
5 ft	lb			3480	3090	1790	1610	1100	1010	640	600	(17.9)
Ground	kg			1490	1310	750	680	470	430	310	280	5.28
Line	lb			3280	2890	1650	1500	1040	950	680	620	(17.3)
-1.0 m	kg	*1740	*1740	1500	1310	730	660	460	420	360	330	4.80
-5 ft	lb	*3840	*3840	3310	2890	1610	1460	1010	930	790	730	(15.7)
-2.0 m	kg	*2470	*2470	1530	1350	750	680					
-5 ft	lb	*5450	*5450	3370	2980	1650	1500					

- Lifting capacity is based on SAE J1097, ISO 10567.
- Lifting capacity of the Robex Series does not exceed 75% of the tipping load with the machine on firm, level ground or 87% of full hydraulic capacity.
- The load point is a hook located (standard equipment) on the back of the bucket.
- (*) indicates the load limited by hydraulic capacity.