

STANDARD EQUIPMENT

ISO standard canopy -Canopy ROPS(ISO 3471) FOPS(ISO 3449) FOG(ISO 10262 Level I) TOPS(ISO 12117)	Engine coolant temperature gauge -Warning Quick clamp Engine oil pressure Engine coolant temperature Preheat Low battery Fuel empty	-One key -Mechanical suspension seat with seat belt -Console box tilting system(LH.) -Two front working lights -Electric horn -Battery (1 x 12 V x 80 AH) -Battery master switch -Removable reservoir tank	-Water separator, fuel line -Mono boom (1.80 m, 5' 11") -Arm (0.96 m, 3' 2") -Rubber crawler (230mm, 9") -Double acting piping
--	--	---	--

OPTIONAL EQUIPMENT

-Accumulator, work equipment lowering -Travel alarm -Tool kit	-Lever pattern change valve -Long Arm (1.12m, 3' 8") -Q / Coupler piping -Q / Coupler	-Accumulator, work equipment lowering -Proportional control suitor	-Additional CWT -Accumulator, Work equipment lowering -Proportional Control Switch
---	--	---	--

* Standard and optional equipment may vary. Contact your Hyundai dealer for more information. The machine may vary according to International standards.
* The photos may include attachments and optional equipment that are not available in your area.
* Materials and specifications are subject to change without advance notice.
* All imperial measurements rounded off to the nearest pound or inch.

PLEASE CONTACT

www.hyundai-ce.com

2015.01 Rev. 0

 **HYUNDAI**
HEAVY INDUSTRIES
CONSTRUCTION EQUIPMENT

Head Office
1000 BANGEOJINSUNHWAN-DORO, DONG-GU, ULSAN, 682-792, KOREA
TEL:(82)52-202-7722, 9807 FAX:(82)52-202-7720



We build a better future

Rabex
17Z-9A



*Photo may include optional equipment.

 **HYUNDAI**
HEAVY INDUSTRIES

Pride at Work

Hyundai Heavy Industries strives to build state-of-the-art earthmoving equipment to give every operator maximum performance, more precision, versatile machine preferences, and proven quality. Take pride in your work with Hyundai!

Robex 17z-9A

Machine Walk-Around

Rugged Upper and Lower Frame

The upper frame is designed with an optimum structure to absorb high stress from outside. Reinforced box section center frame and track frame provide exceptional strength and longer service life to withstand the tough working conditions.

Compact design

R17Z-9A's compact design allows the operator to work in confined areas, like close to buildings on roadways, and in urban areas. R17Z-9A's variable undercarriage provides easy and efficient operation in any limited space work environment.

Engine Technology

The R17Z-9A is powered by a proven and reliable, Tier 4 certified KUBOTA D902 Engine. This engine provides efficient fuel combustion and reduced noise.

Efficient Control System

Control devices are all conveniently located for improved operator comfort and productivity. A safety lever on the left-side console is designed to prevent exiting the cab while hydraulic controls are live.

Advanced Hydraulic System

The R17Z-9A hydraulic system is precision designed for fast operation with fine control capabilities.

Comfortable and Durable Cab with Canopy

Canopy frames meet international standards TOPS, ROPS, FOPS, FOG ensuring operator's safety.

Operator Convenience

An adjustable suspension seat, wrist rests, ergonomically designed joysticks and plenty of leg room help to reduce operator fatigue. A array of indicators and gauges are displayed on the monitor which keep the operator aware of machine performance at all times. The monitoring system includes seven warning indicators, water temperature gauge, fuel gauge and hour meter.

Easy and Simple Maintenance

R17Z-9A is equipped with wide opening engine hood for easy access and maintenance. Additional benefits include an easily serviceable air cleaner and centralized grease fittings.

Extended Life of Components

The R17Z-9A reduces operating costs over time with long life hydraulic oil, shims and bushings.



*Photo may include optional equipment.

Safety and Comfort

The R17Z-9A offers an operator an optimal work environment with a cab designed for comfort and sophistication. Operating R17Z-9A is unique to every operator. Operators can fully customize their work environment and operating preferences to fit their individual needs.

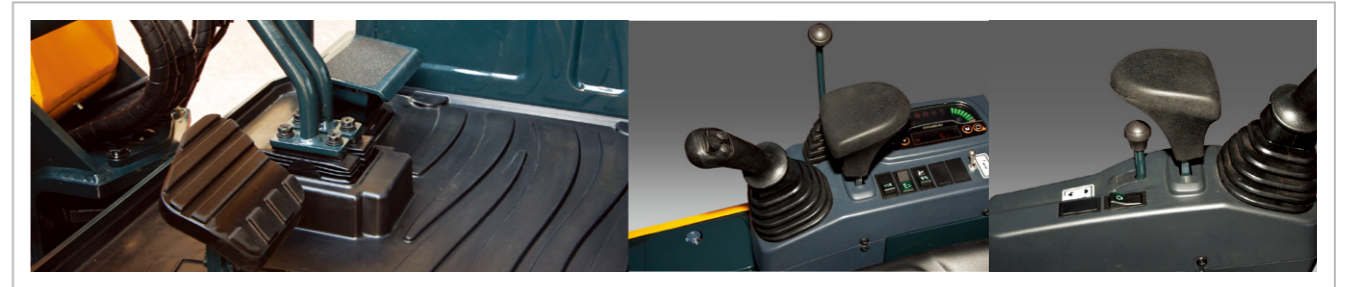

*Photo may include optional equipment.



OLED Display & ESL Function (Engine Start Limit)

OLED display is placed to depict the followings: hour meter, oil pressure, battery charge, engine coolant temperature and a fuel gauge. Theft Prevention Function is added.



Concentrated Controller Position

The left and right control levers are ergonomically located for convenient access. Pilot operated hand levers are easily accessible for controlling the dozer blade and track extension. Easy-to-access control switches on the left side console improve operating comfort and productivity.



A tiltable left-side console allows the operator easier access to the cab. A safety lock system is designed to prevent exiting the cab while hydraulic controls are live. When the safety lever and left side console are positioned upright, hydraulic functions are disengaged.

Emergency Stop Switch

At the event of an emergency, engines shutdown.

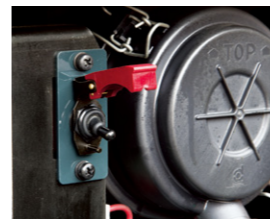

Two Outlet Sockets

Sockets may be used for multiple purposes.



Operator Comfort

An operator's work environment should be stress free. Hyundai R17Z-9A's adjustable suspension seat, wrist rests, ergonomically designed joysticks and plenty of space help to reduce stress on the operator.

Front Guard with the Foot Rest

Cross pipe is placed for front guard reinforcement. Also, an operator may use it as a foot rest.



*Photo may include optional equipment.

Great Performance

New technologies designed to improve performance and precision, make the R17Z-9A smooth, fast and easy to control.



*Photo may include optional equipment.

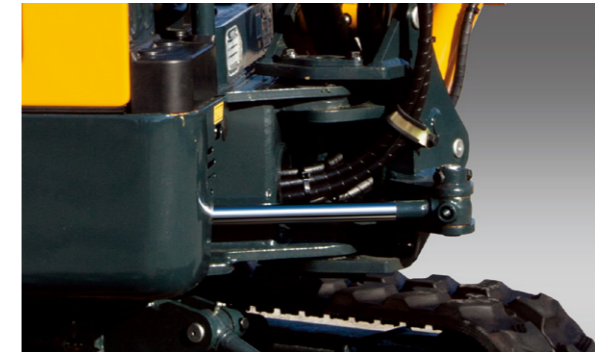

Boom Swing (LH:70' RH:54')

The R17Z-9A's boom swing function is designed for efficient work in congested residential and urban areas. The boom can be offset left or right within an operating range.



Zero-Tail Swing

Zero-tail swing excavator allows you greater flexibility when working in narrow urban areas from an alley and indoor to residential and small gardens.

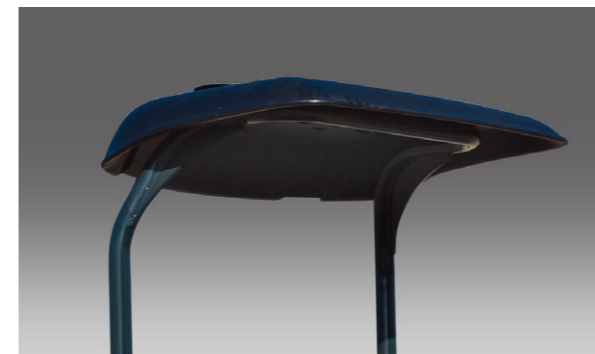

Structure Strength

The R17Z-9A canopy structure has been fitted with stronger but slimmer tubing for added safety and improved visibility. Low-stress, high strength steel is integrally welded to form a stronger, more durable upper and lower frame. Structural integrity was tested by rear machine test and long-term durability tests.

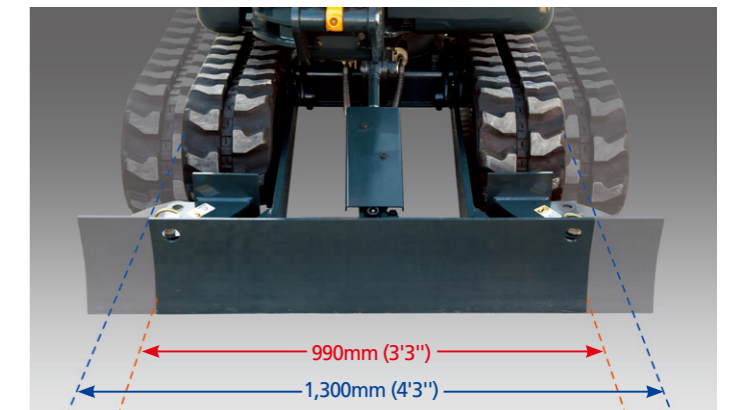

Variable Undercarriage

R17Z-9A's track width adjusts to between 990mm~1,300mm (3'3"~4'3"). The operator can easily adjust the blade size by removing the pin. Specially designed rubber-padded track shoes protect the road surface.

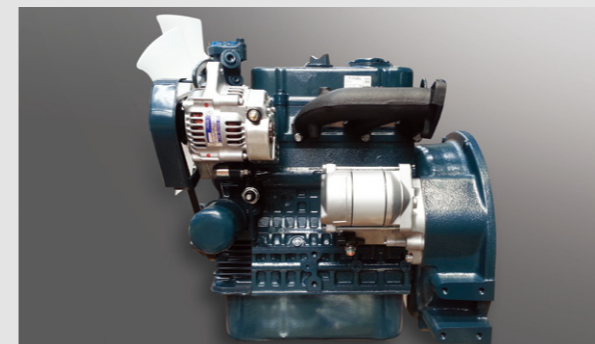

Kubota D902

Emissions: The most compact multi-cylinder liquid cooled industrial diesel engines comply with EPA Tier 4 Emission regulations without additional After Treatment Tools. This engine meets standards over the NRTC and NTE requirements.

Lower Noise Level: The half-float valve cover and MoS2 coated piston reduce noise levels and vibration.

Easy Maintenance

R17Z-9A is designed to maximize profitability through improved efficiencies, enhanced service features and longer life components.

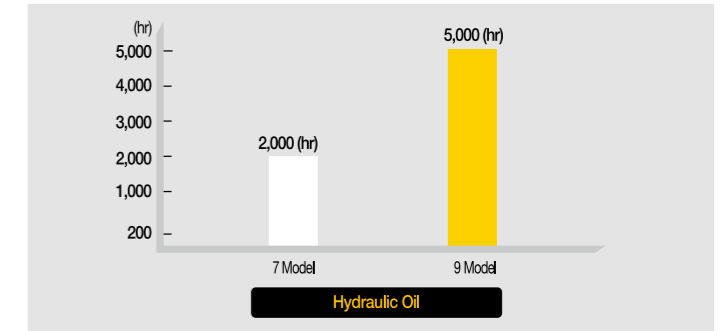

*Photo may include optional equipment.



Easy Access

The R17Z-9A was built with accessibility in mind. All covers and hoods were built for complete open access. Regular service and maintenance is easy and convenient with the R17Z-9A.



Extended the Life of Components

9A series excavators were designed with bushings designed for extended lube intervals (250 hrs) & polymer shims (wear resistant, noise reducing), extended-life hydraulic filters (1,000hrs), long-life hydraulic oil (5,000hrs), more efficient cooling systems and integrated preheating systems which extend service intervals, minimize operating costs and reduce machine down time.



Cooler Cleaning at Ease

The Square Wave Fin and the Corrugate Wave Fin which are better at clogging issue were applied to the radiator and the oil cooler.

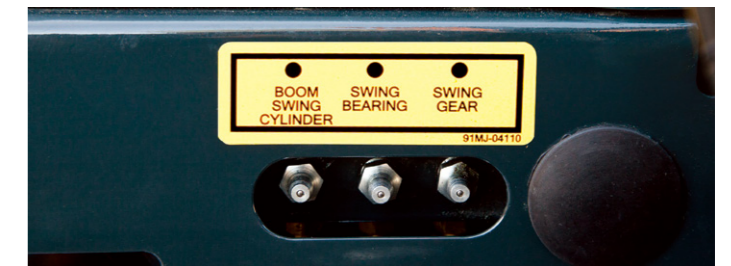

Centralized Grease Fittings

Centralized lubrication bank for faster, easier service and maintenance.



Two-Piece Hose for the Dozer Cylinder

Two piece hoses were applied for a better and easier maintenance.



Easier to Transport

Four tying-down holes allow easier transportation.



Protection Covers for Cylinders

The standard boom cylinder cover and the dozer cylinder cover was applied to protect cylinders from potential damages.

Specifications

ENGINE

Model	KUBOTA D902	
Type	4 cycle, In line, Water cooled, Diesel, Tier 4 certified	
Rated flywheel horse power		
SAE	J1995 (gross)	16.3hp (12.1kw) / 2,300rpm
	J1349 (net)	15.8hp (11.8kw) / 2,300rpm
DIN	627 1/1 (gross)	16.5ps (13.1kw) / 2,300rpm
	627 1/1 (net)	16.0ps (11.8kw) / 2,300rpm
Max. torque	5.6 kgf·m(36lbf·ft) at 1,900 rpm	
Bore x stroke	72mm(2.83")x73.6mm(2.89")	
Piston displacement	898cc (54.79in ³)	
Batteries	12V, 45AH	
Starting motor	12V, 1.2kW	
Alternator	12V, 40A	

HYDRAULIC SYSTEM

Main pumps		
Type	Variable displacement piston pumps	
Rated flow	2x18.8 ℓ/min + 11.3 ℓ/min	
Sub-pump for pilot circuit	Gear pump	
Hydraulic motors		
Travel	Two speed axial piston motor with counter balance valve	
Swing	Axial piston motor	
Relief valve setting		
Implement circuits	210 kgf/cm ² (2,987 psi)	
Travel circuit	210 kgf/cm ² (2,987 psi)	
Swing circuit	170 kgf/cm ² (2,418 psi)	
Pilot circuit	35 kgf/cm ² (498 psi)	
Service valve	Installed	

HYDRAULIC CYLINDER

No. of cylinder - bore x stroke		
Boom	60 x 440mm (2.3" x 17.3")	
Arm	60 x 353mm (2.3" x 13.8")	
Bucket	55 x 320mm (2.16" x 12.59")	
Boom swing	55 x 355mm (2.16" x 13.97")	
Dozer blade	65 x 45mm (2.5" x 4.5")	
Extension	55 x 310mm (2.16" x 12.2")	

NOISE LEVEL

Noise Levels (dynamic value)		
LwA	93dB	
LpA	81dB	

COOLANT & LUBRICANT CAPACITY

(refilling)	liter	US gal	UK gal
Fuel tank	20	5.3	4.4
Engine coolant	3.5	0.9	0.7
Engine oil	4.2	1.1	0.9
Hydraulic tank	12.5	3.3	2.7

TRAVEL LEVERS

Traveling and steering : Two levers with pedals.

CONTROL LEVERS

Type		
Pilot control	Two joysticks with one safety lever (LH): Swing and arm, (RH): Boom and bucket with horn (ISO)	
Engine throttle	Mechanical, cable type	

SWING SYSTEM

Swing motor	Orbit motor
Swing reduction	-
Swing circuit lubrication	Lubricated with drain oil
Swing speed	9.5 rpm

DRIVES & BRAKES

Max. travel speed(high) / (low)	4.2km / 2.2km (2.6mph) / (1.4mph)
Maximum traction force	1.42ton
Maximum gradeability	30°

DIGGING FORCE(ISO)

	0.96m Arm	1.12m Arm
Bucket	1,580 kgf	1,580 kgf
	15.5 kN	15.5 kN
Arm	3,480 lbf	3,480 lbf
	870 kgf	780 kgf
	8.5 kN	7.6 kN
	1,920 lbf	1,720 lbf

WEIGHT(APPROXIMATE)

Operating weight, including 1,800 mm (5' 11") boom, 960 mm (3' 2") arm, SAE heaped 0.04 m³ (0.05 yd³) excavator bucket, lubricant, coolant, full fuel tank, hydraulic tank and the standard equipment.

Shoe width	Rubber shoe 230mm(9")
Operating weight (canopy)	1,700kg (3,747lb)
Ground pressure (canopy)	0.28kg/cm ² (3.92psi)

UNDERCARRIAGE









Center frame is integrally welded with reinforced box-section track frames. The undercarriage includes lubricated rollers, track adjusters with shock absorbing springs and sprockets, and rubber shoes.

Track frame	Variable undercarriage
No. of track roller on each side	3 EA









LIFTING CAPACITIES R17Z-9A

 Rating over-front  Rating over-side or 360 degree

Boom : 1.80m (5' 11") / Arm : 0.96 m (3' 2") / Bucket : 0.04m³ SAE heaped / Dozer up, Track extended, 230mm (9") Rubber track, W/O ADD' CWT.

Load point height m (ft)	Load radius						At max. reach		
	2.0 m (7.0 ft)		2.5 m (8.0 ft)		3.0 m (10.0 ft)		Capacity		Reach m (ft)
									
3.0 m (10.0 ft)	kg						280	*290	2.63
	lb						620	*640	(8.6)
2.5 m (8.0 ft)	kg		310	*310			200	210	3.13
	lb		680	*680			440	460	(10.3)
2.0 m (7.0 ft)	kg		300	310	210	220	170	180	3.43
	lb		660	680	460	490	370	400	(11.3)
1.5 m (5.0 ft)	kg	430	440	290	210	220	150	160	3.60
	lb	950	970	640	460	490	330	350	(11.8)
1.0 m (3.0 ft)	kg	400	410	270	290	210	140	150	3.67
	lb	880	900	600	640	440	310	330	(12.0)
0.5 m (2.0 ft)	kg	370	390	260	270	190	140	150	3.64
	lb	820	860	570	600	420	310	330	(11.9)
Ground	kg	360	370	250	270	190	150	160	3.51
Line	lb	790	820	550	600	420	330	350	(11.5)
-0.5 m (-2.0 ft)	kg	360	370	250	260	190	170	180	3.27
	lb	790	820	550	570	420	370	400	(10.7)
-1.0 m (-3.0 ft)	kg	360	380	250	270		210	220	2.87
	lb	790	840	550	600		460	490	(9.4)
-1.5 m (-5.0 ft)	kg	380	390						
	lb	840	860						

Boom : 1.80m (5' 11") / Arm : 0.96 m (3' 2") / Bucket : 0.04m³ SAE heaped / Dozer down, Track extended, 230mm (9") Rubber track, W/O ADD' CWT.

Load point height m (ft)	Load radius						At max. reach			
	2.0 m (7 ft)		2.5 m (8 ft)		3.0 m (10 ft)		Capacity		Reach m (ft)	
										
3.0 m (10.0 ft)	kg						*290	*290	2.63	
	lb						*640	*640	(8.6)	
2.5 m (8.0 ft)	kg			*310	*310		*290	220	3.13	
	lb			*680	*680		*640	490	(10.3)	
2.0 m (7.0 ft)	kg			*320	*320	*320	230	*300	180	3.43
	lb			*710	*710	*710	510	*660	400	(11.3)
1.5 m (5.0 ft)	kg	*450	*450	*380	310	*340	230	*300	160	3.60
	lb	*990	*990	*840	680	*750	510	*660	350	(11.8)
1.0 m (3.0 ft)	kg	*620	430	*450	300	*380	220	*310	150	3.67
	lb	*1370	950	*990	660	*840	490	*680	330	(12.0)
0.5 m (2.0 ft)	kg	*740	400	*520	280	*410	210	*320	150	3.64
	lb	*1630	880	*1150	620	*900	460	*710	330	(11.9)
Ground	kg	*790	390	*550	270	*420	210	*330	160	3.51
Line	lb	*1740	860	*1210	600	*930	460	*730	350	(11.5)
-0.5 m (-2.0 ft)	kg	*760	390	*540	270	*400	210	*330	180	3.27
	lb	*1680	860	*1190	600	*880	460	*730	400	(10.7)
-1.0 m (-3.0 ft)	kg	*660	390	*470	270			*320	230	2.87
	lb	*1460	860	*1040	600			*710	510	(9.4)
-1.5 m (-5.0 ft)	kg	*450	400							
	lb	*990	880							

1. Lifting capacity are based on SAE J1097, ISO 10567.

2. Lifting capacity of the Robex Series does not exceed 75% of the tipping load with the machine on firm, level ground or 87% of full hydraulic capacity.

3. The load point is a hook (Standard equipment) located on the back of the bucket.

4. (*) Indicates load limited by hydraulic capacity.

Specifications

LIFTING CAPACITIES R17Z-9A

Rating over-front Rating over-side or 360 degree

Boom : 1.80m (5' 11") / Arm : 1.12 m (3' 8") / Bucket : 0.04m³ SAE heaped / Dozer up, Track extended, 230mm (9") Rubber track, W/O ADD' CWT.

Load point height m (ft)	Load radius								At max. reach		
	2.0 m (7.0 ft)		2.5 m (8.0 ft)		3.0 m (10.0 ft)		3.5 m (12.0 ft)		Capacity		Reach m (ft)
3.0 m (10.0 ft)	kg								240	250	2.87
	lb								530	550	(9.4)
2.5 m (8.0 ft)	kg		*260	*260					180	190	3.31
	lb		*570	*570					400	420	(10.9)
2.0 m (7.0 ft)	kg		*280	*280	210	220			150	160	3.59
	lb		*620	*620	460	490			330	350	(11.8)
1.5 m (5.0 ft)	kg	*380	*380	290	300	210	220		140	140	3.75
	lb	*840	*840	640	660	460	490		310	310	(12.3)
1.0 m (3.0 ft)	kg	400	420	280	290	200	210	150	130	140	3.82
	lb	880	930	620	640	440	460	330	290	310	(12.5)
0.5 m (2.0 ft)	kg	370	390	260	270	190	200	150	130	140	3.79
	lb	820	860	570	600	420	440	330	290	310	(12.4)
Ground Line	kg	360	370	250	260	190	200		130	140	3.67
	lb	790	820	550	570	420	440		290	310	(12.0)
-0.5 m (-2.0 ft)	kg	350	370	240	260	180	190		150	160	3.45
	lb	770	820	530	570	400	420		330	350	(11.3)
-1.0 m (-3.0 ft)	kg	350	370	250	260				180	190	3.08
	lb	770	820	550	570				400	420	(10.1)
-1.5 m (-5.0 ft)	kg	360	380						270	*280	2.47
	lb	790	840						600	*620	(8.1)

Boom : 1.80m (5' 11") / Arm : 1.12 m (3' 8") / Bucket : 0.04m³ SAE heaped / Dozer down, Track extended, 230mm (9") Rubber track, W/O ADD' CWT.

Load point height m (ft)	Load radius								At max. reach		
	2.0 m (7.0 ft)		2.5 m (8.0 ft)		3.0 m (10.0 ft)		3.5 m (11.0 ft)		Capacity		Reach m (ft)
3.0 m (10.0 ft)	kg								*270	260	2.87
	lb								*600	570	(9.4)
2.5 m (8.0 ft)	kg		*260	*260					*270	200	3.31
	lb		*570	*570					*600	440	(10.9)
2.0 m (7.0 ft)	kg		*280	*280	*290	230			*270	170	3.59
	lb		*620	*620	*640	510			*600	370	(11.8)
1.5 m (5.0 ft)	kg	*380	*380	*340	310	*320	230		*280	150	3.75
	lb	*840	*840	*750	680	*710	510		*620	330	(12.3)
1.0 m (3.0 ft)	kg	*550	430	*420	300	*350	220	*250	*290	140	3.82
	lb	*1210	950	*930	660	*770	490	*550	*640	310	(12.5)
0.5 m (2.0 ft)	kg	*700	400	*490	280	*390	210	*270	*300	140	3.79
	lb	*1540	880	*1080	620	*860	460	*600	*660	310	(12.4)
Ground Line	kg	*770	390	*540	270	*410	200		*310	150	3.67
	lb	*1700	860	*1190	600	*900	440		*680	330	(12.0)
-0.5 m (-2.0 ft)	kg	*770	380	*540	270	*410	200		*310	160	3.45
	lb	*1700	840	*1190	600	*900	440		*680	350	(11.3)
-1.0 m (-3.0 ft)	kg	*700	380	*500	270				*310	200	3.08
	lb	*1540	840	*1100	600				*680	440	(10.1)
-1.5 m (-5.0 ft)	kg	*530	390						*280	*280	2.47
	lb	*1170	860						*620	*620	(8.1)

1. Lifting capacity are based on SAE J1097, ISO 10567.
2. Lifting capacity of the Robex Series does not exceed 75% of the tipping load with the machine on firm, level ground or 87% of full hydraulic capacity.

3. The load point is a hook (Standard equipment) located on the back of the bucket.
4. (*) Indicates load limited by hydraulic capacity.

Dimensions & Working Range

R17Z-9A DIMENSIONS

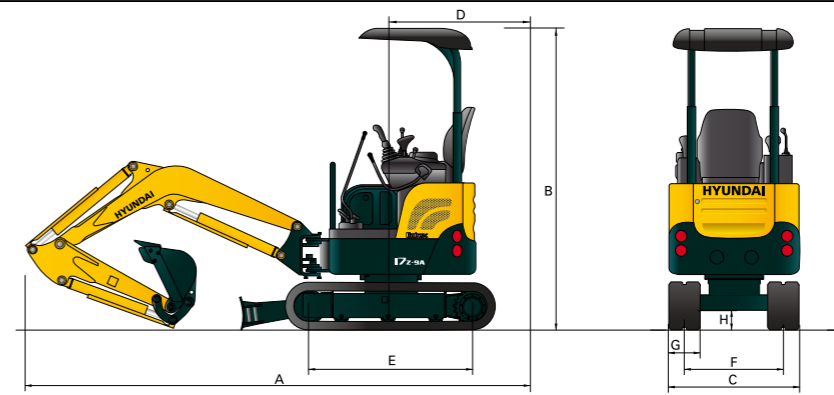

unit: mm(ft-in)

A Overall length	3,480 [3,510] (11'4")	E Tumbler distance	1,230 (4'0")
B Overall height	2,320 (7'7")	F Track gauge	760~1,070 (2'6"~3'5")
C Overall width	990~1,300 (3'2"~4'2")	G Track shoe width	230 (0'9")
D Tail swing radius	645 (2'11") 720(2'3") (With ADD' CWT)	H Ground clearance	170 (0'5")

[]:Long Arm

R17Z-9A WORKING RANGE

unit: mm(ft-in)

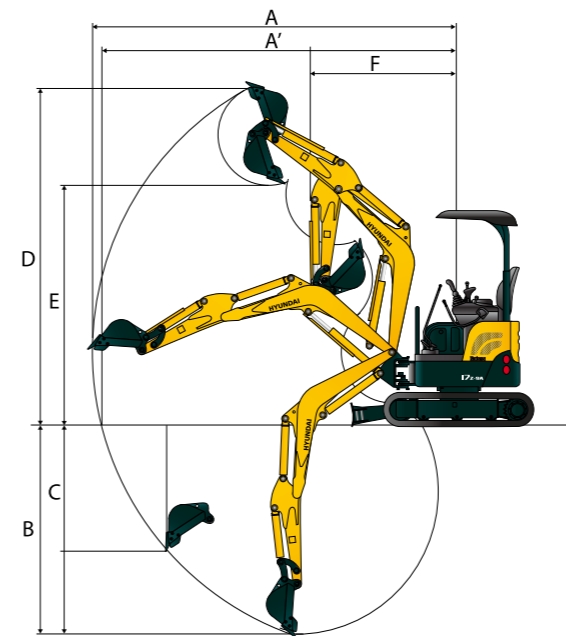

Boom length	1,800 (5'11")	
Arm length	960 (3'2")	1,120 (3'8")
A Max. digging reach	3,900 (12'7")	4,030 (13'2")
A' Max. digging reach at ground	3,800 (12'4")	3,940 (12'9")
B Max. digging depth	2,200 (7'2")	2,350 (7'7")
C Max. vertical wall digging depth	1,320 (4'3")	1,460 (6'3")
D Max. digging height	3,580 (11'7")	3,680 (12'0")
E Max. dumping height	2,570 (8'4")	2,670 (8'7")
F Min. swing radius	1,570 (5'1")	1,600 (5'2")