

Dimension

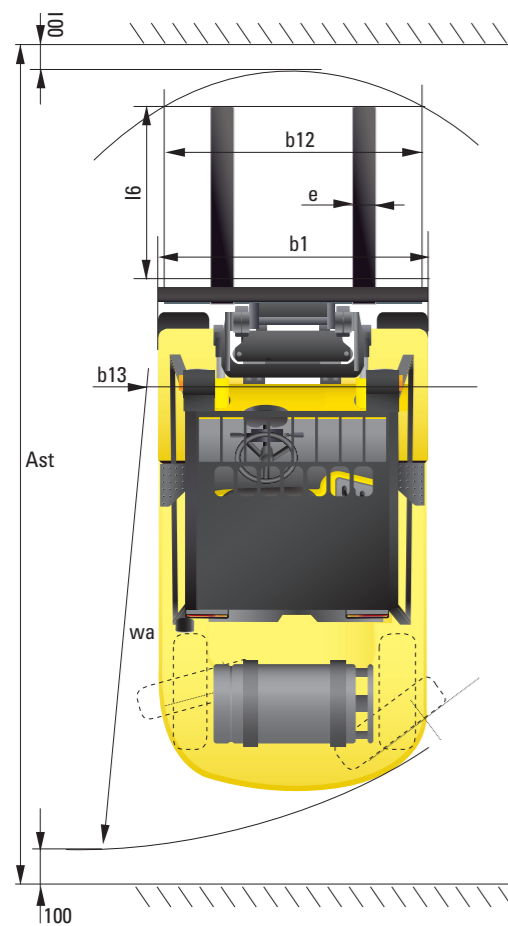

Specification

Identification						
1.1	Manufacturer	Hyundai	Hyundai	Hyundai	Hyundai	
1.2	Manufacturer's type designation	35L-7A	40L-7A	45L-7A	50L-7A	
1.3	Drive: electric (battery or mains), diesel, petrol, fuel gas, manual	LP	LP	LP	LP	
1.4	Type of operation: hand, pedestrian, standing, seated, order-picker	seated	seated	seated	seated	
1.5	Load capacity / rated load	Q (kg)	3,500	4,000	4,500	5,000
1.6	Load center distance	c (mm)	600	600	600	600
1.8	Load distance, center of drive axle to fork	x (mm)	561	561	561	576
1.9	Wheelbase	y (mm)	2,000	2,000	2,000	2,000
Weights						
2.1	Service weight	kg	5,748	6,163	6,579	7,043
2.2	Axle loading, loaded front/rear	kg	8,330/918	9,094/1,069	9,891/1,188	9,926/1,617
2.3	Axle loading, unloaded front/rear	kg	2,798/2,950	2,772/3,391	2,779/3,800	2,814/4,229
Wheels, Chassis						
3.1	Tires: solid rubber, superplastic, pneumatic, polyurethane	Pneumatic / Solid rubber	Pneumatic / Solid rubber	Pneumatic / Solid rubber	Pneumatic / Solid rubber	
3.2	Tires size, front (width x Φ)	8.25 x 15 x 14pr	7.50 x 16 x 12pr	7.50 x 16 x 12pr	7.50 x 16 x 12pr	
3.3	Tires size, rear (width x Φ)	7.00 x 12 x 12pr	7.00 x 12 x 12pr	7.00 x 12 x 12pr	7.00 x 12 x 14pr	
3.5	Wheels, number front x rear (x=driven wheels)	2x2	4x2	4x2	4x2	
3.6	Track width, front	b10 (mm)	1,132	1,282	1,282	
3.7	Track width, rear	b11 (mm)	1,140	1,140	1,140	
Basic Dimensions						
4.1	Mast/fork carriage tilt forward/backward (α / β)	degrees	8 / 10	8 / 10	8 / 10	
4.2	Lowered mast height	h1 (mm)	2,235	2,220	2,220	
4.3	Free lift	h2 (mm)	120	120	120	
4.4	Lift height	h3 (mm)	3,020	3,020	2,930	
4.5	Extended mast height	h4 (mm)	4,224	4,224	4,235	
4.7	Overhead load guard (cab) height	h5 (mm)	2,240	2,240	2,240	
4.8	Seat height / standing height	h7 (mm)	1,100	1,100	1,100	
4.12	Coupling height	h10 (mm)	385	385	385	
4.19	Overall length	l1 (mm)	4,145	4,205	4,405	
4.20	Length to face of forks	l2 (mm)	3,075	3,135	3,185	
4.21	Overall width	b1 (mm)	1,370	1,746	1,746	
4.22	Fork dimensions	s / e / l (mm)	50 x 122 x 1,070	50 x 150 x 1,070	50 x 150 x 1,220	
4.23	Fork carriage ISO 2328, class / type AB		III / A	IV / A	IV / A	
4.24	Fork-carriage width	b12 (mm)	1,300	1,600	1,600	
4.31	Ground clearance, loaded, under mast	m1 (mm)	170	155	155	
4.32	Ground clearance, centre of wheelbase	m2 (mm)	200	200	200	
4.33	Aisle width for pallets 1000x1200 crossways	Ast (mm)	4,567	4,620	4,666	
4.34	Aisle width for pallets 800x1200 lengthways	Ast (mm)	4,767	4,820	4,866	
4.35	Turning radius	Wa (mm)	2,806	2,859	2,905	
4.36	Smallest pivot point distance	b13 (mm)	1,009	1,009	1,009	
Performance Data						
5.1	Travel speed, Unloaded	km/h	23.8	22.9	22.9	
5.2	Lift speed, Loaded/Unloaded	mm/s	510 / 530	510 / 530	440 / 460	
5.3	Lowering speed, Loaded/Unloaded	mm/s	500 / 450	500 / 450	500 / 450	
5.5	Drawbar pull, Loaded	kg	4,002	4,065	3,930	
5.7	Gradient performance, Loaded	%	40.5	36.2	31.6	
5.10	Service brake		Hydraulic	Hydraulic	Hydraulic	
Engine						
6.1	Engine manufacturer / type		GM 4.3L	GM 4.3L	GM 4.3L	
6.2	Engine power acc. to ISO 1585	Kw	70	70	70	
6.3	Rated speed	1/min	2,300	2,300	2,300	
6.4	No. of cylinder / cubic capacity	/cm ³	6 / 4,294	6 / 4,294	6 / 4,294	
Other Details						
8.2	Type of drive control		Power Shift	Power Shift	Power Shift	
8.3	Operating pressure	bar	225 / 168	225 / 168	225 / 168	
8.4	Oil volume	l/min	30	30	30	
8.5	Noise	db(A)	80	80	80	

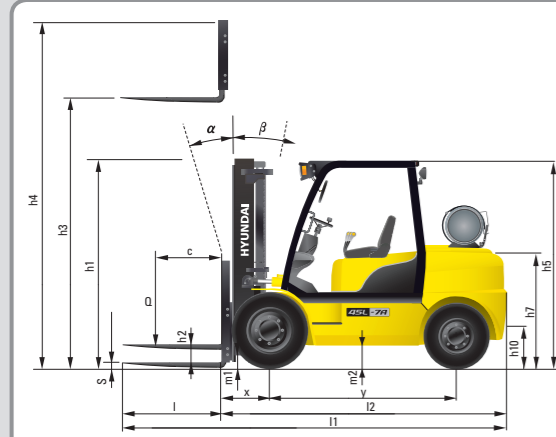

Some of the photos may include optional equipment.

HYUNDAI LPG FORKLIFT TRUCKS **Applied Tier 4 Engine**

35L/40L/45L/50L-7A

HYUNDAI FORKLIFT
HEAVY INDUSTRIES CO.,LTD.

Head Office (Sales Office)
14th FL., HYUNDAI BLDG. 140-2, KYE-DONG, JONGNO-GU, SEOUL, KOREA 110-793
Tel (82) (2) 746-4526, 4529 Fax (82) (2) 746-7444-7445

Americas Operation : Hyundai Construction Equipment Americas, Inc.
955 ESTES AVENUE, ELK GROVE VILLAGE IL, 60007 Tel (1) 847-437-3333 Fax (1) 847-437-3574

Europe Operation : Hyundai Heavy Industries Europe N.V.
VOSSENDAAL 11, 2440 GEEL, BELGIUM Tel (32) 14-56-2200 Fax (32) 14-59-3405

PLEASE CONTACT

www.hyundai-ce.com

2010.09 Rev.0.

HYUNDAI
HEAVY INDUSTRIES CO.,LTD.

We build a better future

NEW criteria of Forklift Trucks

Hyundai introduces a new line of 7A series LPG forklift trucks. Excellent power and performance make your business more profitable.



OPSS (Operator Presence Sensing System)
Control of mast tilting, lifting and lowering is not possible through operation of the appropriate control when the operator is not in the seated position.

■ Some of the photos may include optional equipment.

The new master on the job-site!

Smooth running, efficient and ergonomically designed, 35/40/45/50L-7A series are made to meet your needs.

70Kw/2,300rpm



Powerful Engine GM 4.3L V6 Engine

Market approved quality of GM 4.3L V6 engine ensures incomparable performance, durability and additional value to the machine. Powerful and efficient engine provides excellent fuel economy and excellent torque for improved operation.
(EPA/CARB Tier-IV Certified)

Fast and Stable Performance

Being able to quickly raise and lower the mast, as well as tilt it forward and backward, provides the best operational conditions during unloading.

When the truck is fully loaded, mast lowering speed is carefully controlled to ensure safety by the down control valve.

Mast(Lift and Tilt) Look System is standard.



Some of the photos may include optional equipment.

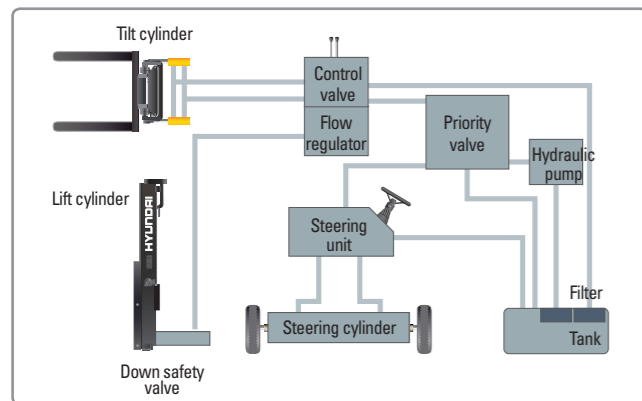

State-of-the-art Hydraulic System

The latest large-capacity hydraulic system reacts quickly during operation, and a low-noise control valve increases both efficiency and durability.



Fully Hydrostatic Power Steering

A hydraulic steering system always guarantees smooth and flexible steering, preventing overrun and kick-back.



Increased Mast Tilting Angle

Utilizing the mast tilting angle of 8 degrees forward and 10 degrees backward, the operator can safely and rapidly perform loading and unloading jobs.

Faster Travel Speed & Better Gradability

The powerful high-output engine provides greater acceleration, better gradability and faster travel speed on any tough terrains or slopes.



Gradability(Loaded)

35L-7A : 40.5% 45L-7A : 31.6%
40L-7A : 36.2% 50L-7A : 28.7%

Travel Speed(Unloaded)

35L-7A : 23.8 km/h
40L-7A : 22.9 km/h
45L-7A : 22.9 km/h
50L-7A : 22.8 km/h

Ergonomic operator friendly compartment design!

A design based on human engineering relieves fatigue and increases operator's efficiency.

Operator Friendly Gauges and Water-resistant Monitor Panel

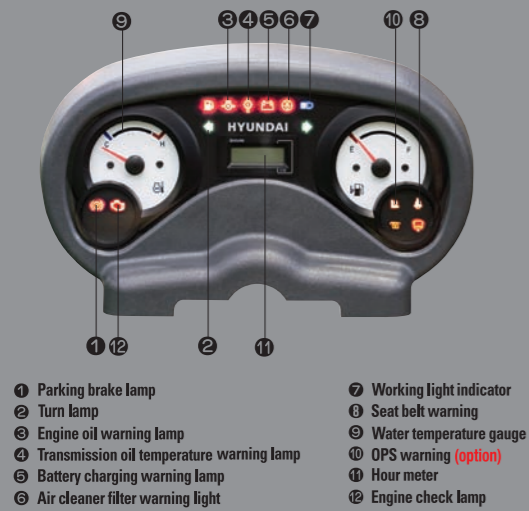

- ① Parking brake lamp
- ② Turn lamp
- ③ Engine oil warning lamp
- ④ Transmission oil temperature warning lamp
- ⑤ Battery charging warning lamp
- ⑥ Air cleaner filter warning light
- ⑦ Working light indicator
- ⑧ Seat belt warning
- ⑨ Water temperature gauge
- ⑩ OPS warning (option)
- ⑪ Hour meter
- ⑫ Engine check lamp



Full Suspension Seat
An attractive and adjustable seat, based on a human engineering design, provides great comfort, safety and durability.



New High Visibility for Safe Operation
The operator is able to work with increased safety and accuracy due to a wider view mast.



■ Some of the photos may include optional equipment.



Ergonomically Positioned Pedals
Based on human engineering, the accelerator, brake and inching pedals are optimally positioned for convenience while operating the equipment.



Cup Holder & Console Box
Additional storage spaces are located inside the operating space for operator's convenience.



Quick Response of Operating Control Levers
Only minimal operator's effort is required for precise, safe and productive control.



Adjustable Steering Wheel
Steering wheel with horn button can be adjusted by a lever on the right-hand side for the most comfortable operator position.



Easy and Safe Shift Lever
A single lever on the left side of the steering column gives the operator fast, easy control of direction. The lever must be in the neutral position before the engine can be started.



Secondary Horn
Secondary Horn gives access to lights and horn.

Danger-free through high durability!

Safety and durability are priorities in design of the equipment.



Strong Overhead Guard

The safety overhead guard meets ISO 6055 regulation and protects the operator during hazardous jobs.



Parking brake

Ratchet type parking brake requires less effort the operator to set.

Highly Durable Split type Drive Axle

The planetary reduction drive axle smoothly delivers desired torque to the drive wheels.



■ Some of the photos may include optional equipment.



Large Footboard & Hand Grip

Wide "open" step offers convenience and safety when entering and exiting truck.



Expansion Bellows

The expansion bellows absorbs vibration and reduces noise generated from the exhaust system and also extends the life cycle of exhaust system.



Electrically Monitored Air Filter

Air cleaner sensor alerts the operator of a restricted air filter and allows replacement before damage.

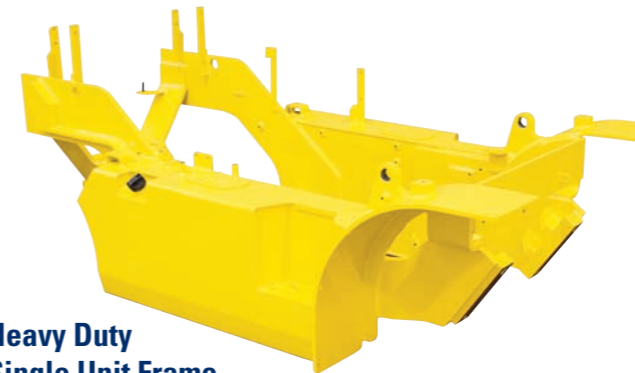

Heavy Duty Single Unit Frame

Heavy duty single unit type frame, designed on the basis of accurate structural analysis, guarantees durability and safety.



Bright, Protected Headlights

Bright, Protected head lights are positioned for exceptional visibility.

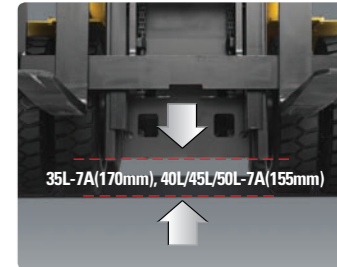

Ground Clearance

The engine and transmission are assembled horizontally and positioned high in the frame to protect major components during operation on rugged surface.

35L-7A(170mm), 40L/45L/50L-7A(155mm)

Designed for quick and easy service!

An ideal arrangement of component parts ensures easy access and convenience for maintenance.



Easy Change Air Cleaner

The air filter is readily accessible for cleaning or replacement. (6inch Cyclone Type)



Fast Service Access for Daily Fluids Check



Maintenance Free Battery



Aluminum Radiator with Superb Protection Against heat



Removable Side Panels for Ease of Service



Easy access of electrical Components

Various electric parts are centralized in dash board resulting in improvement in maintenance.



Easy Maintenance Oil Check

The T/M oil level can be checked easily without any disassembly.



Brake Fluid Reservoir

Highly visible, easily accessible reservoir makes for quicker daily inspections.



An Accessible, Compact Fuse Box for Easy Inspection

Mast Specification

Mast Type	Maximum Fork Height (mm)	Overall Height Lowered (mm)		Free Lift Height (mm)				Tilt Angle (deg)	Load Capacity without side shift at 600mm LC (kg)				Load Capacity with side shift at 600mm LC (kg)				Truck Weight (Unloaded) (kg)																	
		Double Tire		With Backrest		Without Backrest			Single Tire		Double Tire		Single Tire		Double Tire		Single Tire		Double Tire															
		35L/40L 45L-7A	50L-7A	35L/40L 45L/50L-7A	35L/40L 45L-7A	50L-7A	35L/40L 45L-7A		50L-7A	Fwd/Bwd	35L-7A	40L-7A	45L-7A	50L-7A	35L-7A	40L-7A	45L-7A	50L-7A	35L-7A	40L-7A	45L-7A	50L-7A												
2-Stage Limited Free Lift	V270	2,720	2,630	2,085	2,070	120	120	120	120	8/10	3,500	4,000	4,500	5,000	3,500	4,000	4,500	5,000	3,500	4,000	4,500	5,000	5,563	6,027	6,440	6,906	5,718	6,133	6,549	7,018				
	*V300	3,020	2,930	2,235	2,220	120	120	120	120	8/10	3,500	4,000	4,500	5,000	3,500	4,000	4,500	5,000	3,500	4,000	4,500	4,950	3,500	4,000	4,500	4,950	5,593	6,057	6,470	6,931	5,748	6,163	6,597	7,043
	V330	3,320	3,230	2,385	2,370	120	120	120	120	8/10	3,500	4,000	4,500	5,000	3,500	4,000	4,500	5,000	3,500	4,000	4,450	4,850	3,500	4,000	4,450	4,850	5,631	6,095	6,508	6,956	5,786	6,201	6,617	7,068
	V360	3,520	3,430	2,535	2,520	120	120	120	120	8/10	3,500	4,000	4,500	5,000	3,500	4,000	4,500	5,000	3,450	3,950	4,400	4,800	3,450	3,950	4,400	4,800	5,684	6,118	6,531	6,981	5,809	6,224	6,640	7,093
	V370	3,720	3,630	2,635	2,620	120	120	120	120	8/10	3,500	4,000	4,500	5,000	3,500	4,000	4,500	5,000	3,400	3,900	4,350	4,750	3,400	3,900	4,300	4,700	5,674	6,138	6,551	6,998	5,829	6,244	6,660	7,109
	V400	4,020	3,930	2,845	2,830	120	120	120	120	8/10	3,500	4,000	4,500	4,900	3,500	4,000	4,500	5,000	3,350	3,800	4,250	4,650	3,350	3,800	4,250	4,650	5,717	6,181	6,594	7,033	5,871	6,287	6,702	7,145
2-Stage Full Free Lift	V450	4,520	4,430	3,095	3,080	120	120	120	120	8/6	3,450	3,900	4,350	4,750	3,450	3,900	4,350	4,800	3,250	3,700	4,100	4,450	3,250	3,700	4,100	4,500	5,829	6,293	6,706	7,136	5,984	6,399	6,815	7,248
	V500	5,020	4,930	3,345	3,330	120	120	120	120	8/6	3,350	3,750	4,200	4,600	3,350	3,850	4,250	4,650	3,150	3,550	4,000	4,300	3,150	3,600	3,950	4,350	5,884	6,348	6,757	7,178	6,035	6,450	6,866	7,293
	VF280	2,805	2,697	2,135	2,120	1,258	905	919	1,223	8/8	3,500	4,000	4,500	5,000	3,500	4,000	4,500	5,000	3,500	4,000	4,500	5,000	3,500	4,000	4,500	5,000	5,604	6,068	6,476	6,924	5,756	6,171	6,585	7,036
	VF300	3,005	2,897	2,235	2,220	1,358	1,005	1,019	1,323	8/8	3,500	4,000	4,500	5,000	3,500	4,000	4,500	5,000	3,500	4,000	4,500	4,950	3,500	4,000	4,500	4,950	5,630	6,094	6,502	6,949	5,782	6,197	6,611	7,061
	VF315	3,155	3,047	2,325	2,310	1,448	1,095	1,109	1,413	8/8	3,500	4,000	4,500	5,000	3,500	4,000	4,500	5,000	3,450	4,000	4,500	4,900	3,500	4,000	4,450	4,900	5,650	6,114	6,502	6,967	5,802	6,216	6,630	7,079
	TF370	3,730	3,672	2,035	2,020	812	807	1,139	1,074	8/8	3,500	4,000	4,500	5,000	3,500	4,000	4,500	5,000	3,300	3,850	4,250	4,650	3,300	3,850	4,250	4,650	5,824	6,284	6,697	7,108	5,975	6,355	6,808	7,212
3-Stage Full Free Lift	TF400	4,030	3,972	2,135	2,120	912	907	1,239	1,174	8/8	3,450	4,000	4,450	4,900	3,500	4,000	4,450	4,900	3,250	3,750	4,200	4,600	3,300	3,750	4,150	4,600	5,850	6,314	6,727	7,134	6,005	6,385	6,838	7,238
	TF430	4,330	4,272	2,235	2,220	1,012	1,007	1,339	1,274	8/8	3,400	3,900	4,350	4,800	3,450	3,950	4,350	4,800	3,150	3,700	4,100	4,500	3,200	3,700	4,100	4,500	5,881	6,345	6,758	7,159	6,036	6,416	6,869	7,263
	TF450	4,510	4,452	2,295	2,290	1,072	1,067	1,389	1,334	8/8	3,350	3,900	4,300	4,750	3,400	3,950	4,300	4,750	3,150	3,700	4,050	4,450	3,200	3,700	4,050	4,450	5,900	6,364	6,777	7,176	6,055	6,435	6,888	7,273
	TF470	4,720	4,662	2,385	2,390	1,162	1,157	1,489	1,424	8/8	3,300	3,850	4,250	4,650	3,350	3,900	4,250	4,700	3,100	3,600	4,000	4,400	3,150	3,650	4,000	4,400	5,936	6,400	6,813	7,199	6,091	6,471	6,925	7,309
	TF500	5,020	4,962	2,485	2,470	1,262	1,257	1,589	1,524	8/6	3,250	3,750	4,150	4,600	3,300	3,750	4,200	4,600	3,050	3,500	3,900	4,350	3,100	3,550	3,900	4,350	5,960	6,423	6,836	7,224	6,114	6,494	6,948	7,328
	TF550	5,520	5,462	2,665	2,650	1,442	1,437	1,769	1,704	8/6	3,100	3,600	4,000	4,450	3,250	3,650	4,050	4,500	2,750	3,250	3,650	4,200	3,000	3,450	3,800	4,200	6,021	6,485	6,898	7,276	6,175	6,555	7,009	7,380
TF600	6,030	5,972	2,845	2,830	1,622	1,617	1,949	1,884	8/6	2,600	3,050	3,300	4,150	3,100	3,500	3,900	4,350	2,450	2,900	3,100	3,500	2,900	3,300	3,650	4,100	6,089	6,553	6,966	7,317	6,244	6,624	7,077	7,420	

*Standard

Load Capacity

35L-7A

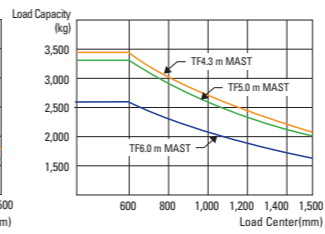
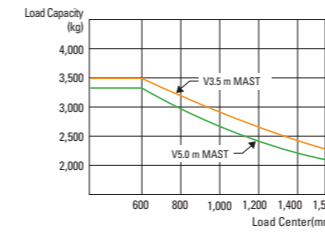

40L-7A

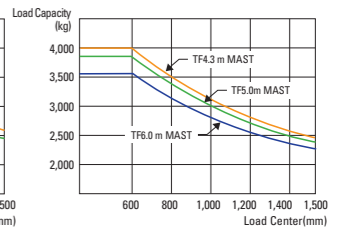
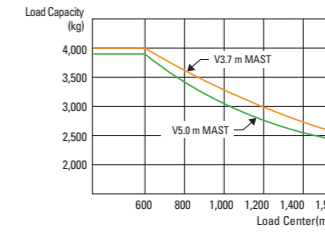

45L-7A

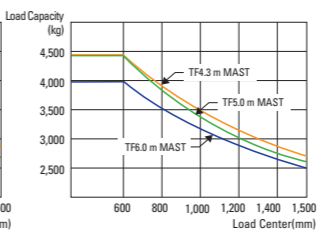
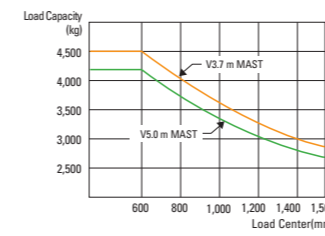

50L-7A

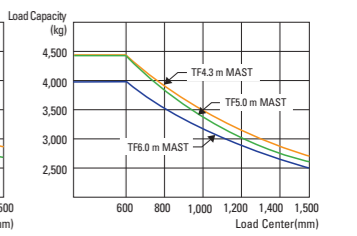
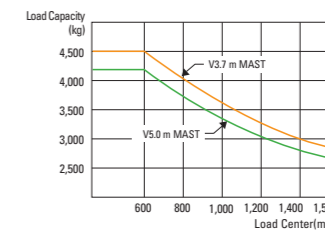

Optional Items

- CABIN
- SIDE SHIFT
- INTEGRAL FORK POSITIONER
- FORK
- 35L/40L-7A : 1,220, 1,370, 1,520, 1,670, 1,820, 1,970mm
- 45L/50L-7A : 1,070, 1,370, 1,520, 1,670, 1,820, 1,970mm
- OPSS (Travel / Travel + mast)
- OVER SHOE : 71 in, 79 in, 87 in
- TILTING : 8/6°, 8/8°
- TIRE : Cushion, No-marking, Double
- SEAT : Pocket, Arm Rest, Hip Rest
- LPG CLAMP : Swing Out
- M.C.V : 4-Spool
- ATTACH PIPING : 3 Spool-piping, 4 Spool-piping
- MASTER SWITCH
- BEACON LAMP
- HAZARD SWITCH
- BRAKE PEDAL
- Hydraulic Booster (w/o Accumulator)