

20/25/30/33DT-7

Diesel Counterbalance Trucks

MOVING YOU FURTHER

HYUNDAI HEAVY INDUSTRIES



* Some of the photos may include optional equipment.

 **HYUNDAI**
HEAVY INDUSTRIES

Your satisfaction is **our priority!**

Hyundai introduces a new line of 7-series diesel forklift trucks.

The newly designed 4 wheel counterbalance trucks provide every operator comfortable driving, increased productivity and easy maintenance.



New Diesel Forklift with Proven Quality and Advanced Technology

- Maximum performance
- Spacious operator's cab
- Easy serviceability
- Load weight indicator (Optional)
- OPSS System for safe operation (Optional)



* Some of the photos may include optional equipment.

High Efficiency & Optimal Performance



* Some of the photos may include optional equipment.



Excellent and Economical Hyundai WIA WC30D engine

60PS / 2,500 rpm

Market approved quality of Hyundai WIA WC30D engine ensures incomparable performance, durability and excellent fuel efficiency.

This engine meets EPA Tier 3 and EU stage IIIA emission regulations.

- Excellent engine Durability applied Timing Gear
- Rapid Acceleration Smoke Decrease
- Apply Friction Gear For Reducing Gear Rattle Noise
- One Shot Start at -25°C installed Cold Start Device

Powerful engine and high technology systems provide you with enhanced performance and highest productivity.

20/25/30/33DT-7

Highly durable drive axle

The strengthened drive axle separable from transmission ensures low vibration and easy maintenance. The wet disc type brake is applied for easy operation, smooth response and maintenance free.

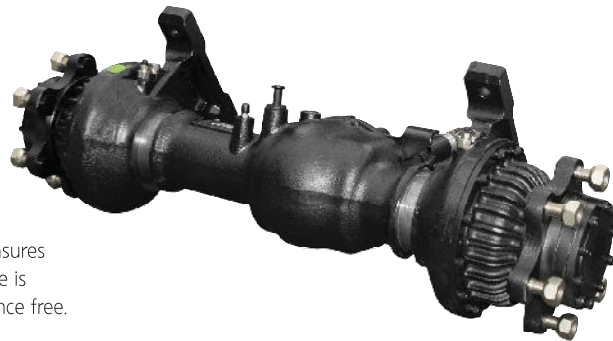

Wet disc brake system

The wet disc brake system is virtually maintenance free and is enclosed to protect from dust and water.

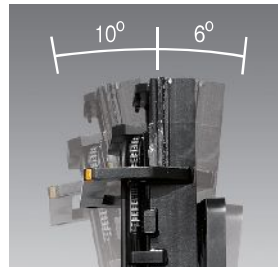

Increased mast tilting angle

Utilizing the standard mast tilting angle of 6 degrees forward and 10 degrees backward, the operator can safely and rapidly perform loading and unloading jobs.



Fully hydrostatic power steering

The hydraulic steering system always guarantees smooth and flexible steering, preventing over-run and kick-back.

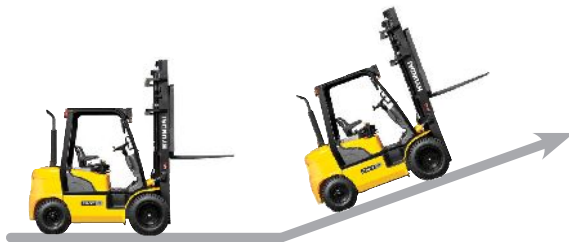

Travel Speed (Max)

Model	km / h
20DT	20.5
25DT	20.5
30DT	21.5
33DT	21.4

Gradeability (Max)

Model	deg
20DT	20.5
25DT	17.8
30DT	14.6
33DT	13.5

Faster travel speed & gradeability

The powerful high-output engine provides greater acceleration, better gradeability and faster travel speed on any tough terrain or slope.

Best Convenience & Optimized Ergonomics



Spacious operator over head guard

The newly designed cabin provides wide visibility and spacious environment, ensuring all day comfort for the operator.



Optimized pedal position

On the 7-series the pedals are mounted to the console to reduce operator fatigue, and noise and dust from the engine compartment.



Low entrance height

The low entrance height ensures easy and safe access for the operator.



Cup holder & console box

Additional storage spaces are located inside the operating space for operator's convenience.



Comfortable Seat

Easily adjustable suspension seat, based on a human engineering design, reduces operator fatigue and provides greater comfort.

*ELR (Energy Locking Retractor) Type Seat Belt

The ergonomically designed cabin and the centralized cluster provides full support and comfort to the operator.

20/25/30/33DT-7

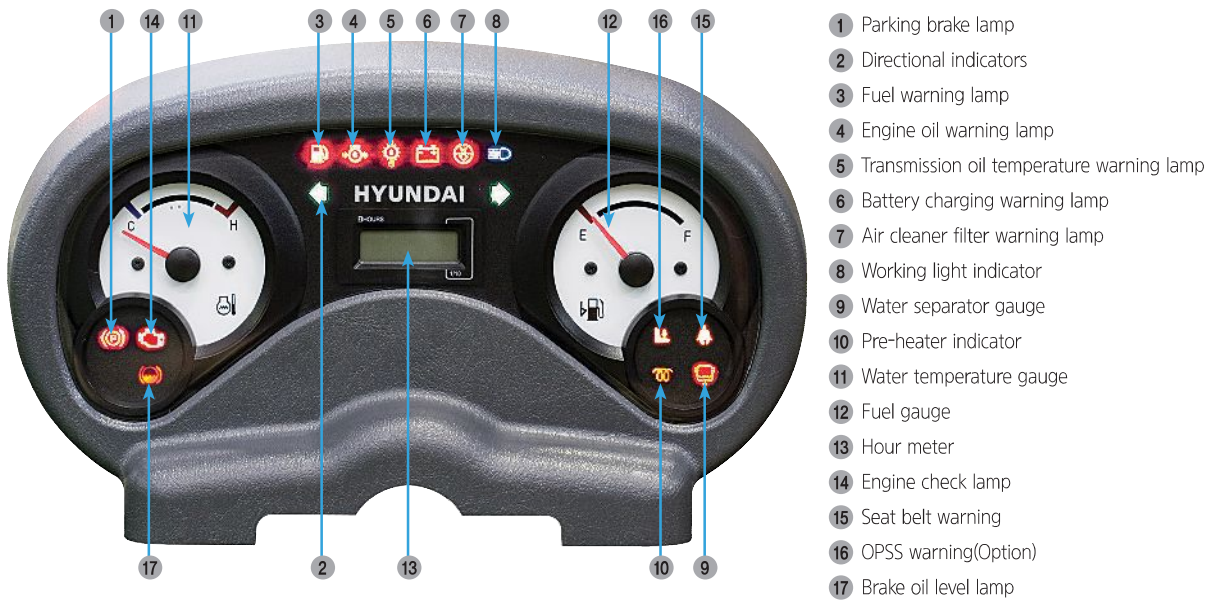

Operator friendly gauges and water-resistant monitor panel



Adjustable steering wheel

To achieve a comfortable drive position, the angle of the steering column can easily be adjusted by a lever on the right-hand side of the steering column.



Easy and safe shift lever

A single lever on the left side of the steering column gives the operator fast, easy control of direction.



Multi-function switch lever

Multi-functional switch lever gives easy access to lights and turning signal.



Quick response of operating control levers

Only minimal operator's effort is required for precise, safe and productive control.

Advanced Safety



Excellent visibility for safe operation

* Some of the photos may include optional equipment.

Optimized lift cylinder arrangement provides operator with wider visibility.
The panoramic mirror expands the driver's view when backing up.



Strong overhead guard

Exceeding CEE and ANSI regulations, the overhead guard offers optimal protection combined with excellent all round visibility.



Convenient hand grip



Parking brake

Ratchet type parking brake requires less efforts from the operator to set.

The safely designed driver's space makes your operating more comfortable.

20/25/30/33DT-7

Fork safety features

When the forks are being lowered, a down-control valve maintains the controlled speed. The down-safety valve prevents forks from dropping down in case of sudden damage of hydraulic line.

OPSS(Operator Presence Sensing System) (Option)

All mast and drive movements stop functioning when the operator is not in the seat.

Lift Lock Tilt Lock Drive Lock Parking



* Some of the photos may include optional equipment.

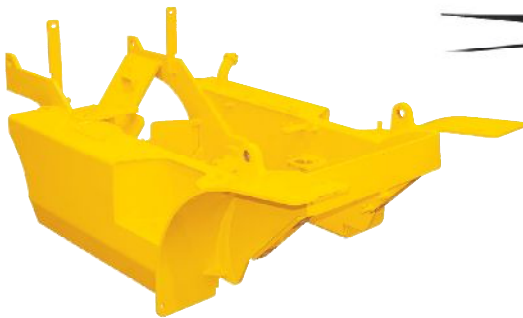

Heavy duty single unit frame

Heavy duty single unit type frame, designed on the basis of accurate structural analysis, guaranteeing durability and safety.



Bright, protected headlights

Bright, protected headlights is positioned for exceptional visibility.

Fast and Easy Maintenance

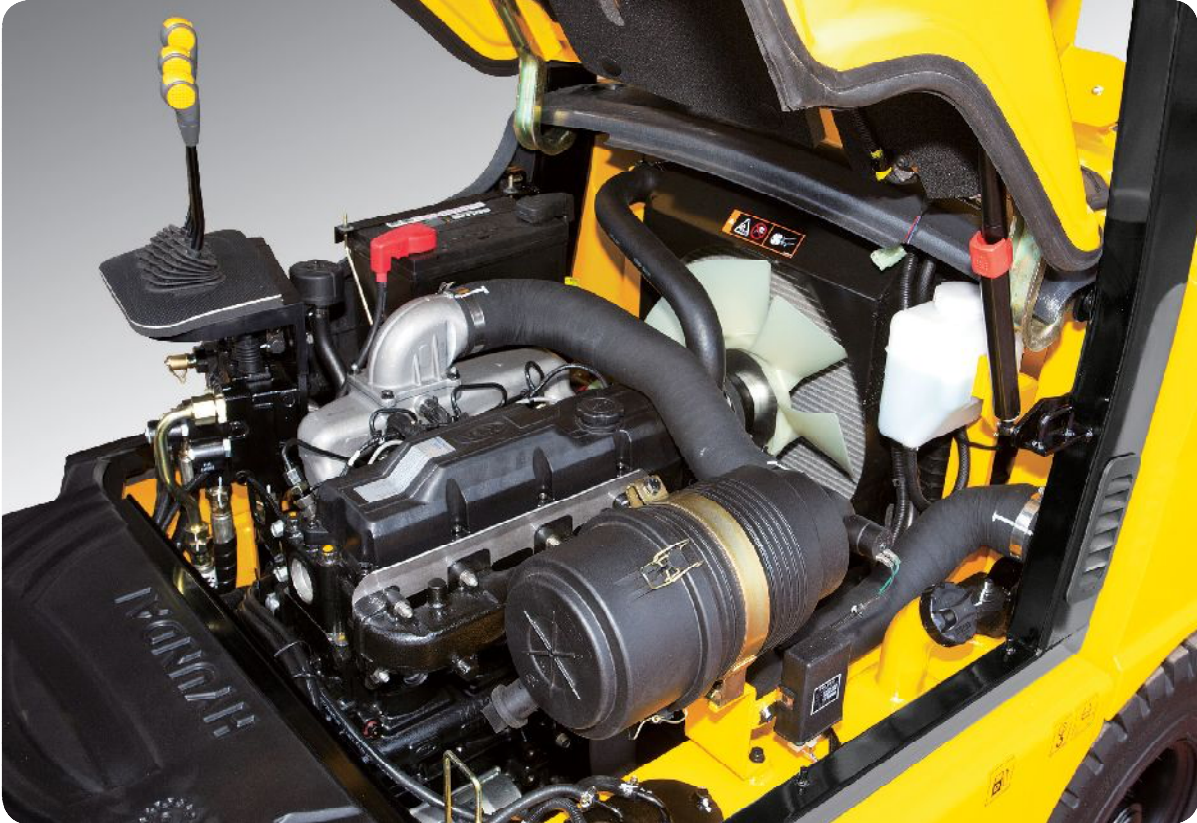

Large open engine hood

Highly accessible engine compartment assures fast and efficient maintenance.

* Some of the photos may include optional equipment.



Easy change air cleaner

The air filter is readily accessible for cleaning or replacement.



Brake fluid reservoir with level switch

When brake oil level becomes lower than Min, the warning lamp on the cluster lights on.



Electrically monitored air filter

Air cleaner sensor alerts the operator of a restricted air filter and allows replacement before damage.



An accessible, compact fuse box for easy inspection

An ideal arrangement of components ensures easy access and convenience for maintenance.

20/25/30/33DT-7



* Some of the photos may include optional equipment.



Portable side cover

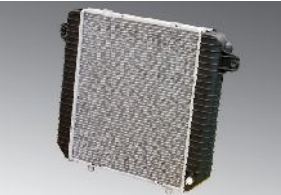

Aluminum radiator with superb protection against heat



Engine oil condition check



Tool-less floor plate for serviceability.

7 Series

Mast Specification (20DT)

Mast Type	Maximum Fork Height (mm)	Overall Height Lowered (mm)	Free Lift Height (mm)		Tilt Angle (Fwd / Bwd)	Load capacity w/o side shift at 500 mm LC (kg)		Load capacity w side shift at 500 mm LC (kg)		Truck Weight Unload (kg)		
			With bkr	With / o bkr		Single Tire	Double Tire	Single Tire	Double Tire	Single Tire	Double Tire	
			20DT	20DT		20DT	20DT	20DT	20DT	20DT	20DT	
2-Stage Limited free lift	V300	3000	2025	155	155	6 / 10	2000	2000	2000	2000	3390	3546
	* V330	3300	2175	155	155	6 / 10	2000	2000	2000	2000	3410	3566
	V350	3500	2275	155	155	6 / 10	2000	2000	2000	2000	3427	3583
	V370	3700	2425	155	155	6 / 10	2000	2000	2000	2000	3449	3605
	V400	4000	2575	155	155	6 / 10	2000	2000	2000	2000	3479	3635
	V430	4300	2725	155	155	6 / 6	2000	2000	1925	2000	3531	3687
	V450	4500	2875	155	155	6 / 6	1970	2000	1895	2000	3553	3709
2-Stage full free lift	V470	4700	2975	155	155	6 / 6	1940	2000	1865	1925	3567	3723
	V500	5000	3125	155	155	6 / 6	1900	1940	1825	1865	3589	3745
	VF290	2900	2025	845	1377	6 / 6	2000	2000	2000	2000	3425	3593
	VF320	3200	2175	995	1527	6 / 6	2000	2000	2000	2000	3459	3626
	TF / TS370	3700	1825	645	1177	6 / 6	2000	2000	2000	2000	3516	3683
	TF / TS400	4000	1925	745	1277	6 / 6	2000	2000	1925	2000	3540	3707
	TF / TS430	4300	2025	845	1377	6 / 6	1950	2000	1875	1925	3558	3725
3-Stage full free lift	TF / TS450	4500	2125	945	1477	6 / 6	1930	1960	1855	1885	3580	3747
	TF / TS470	4700	2175	995	1527	6 / 6	1890	1930	1815	1855	3593	3761
	TF / TS500	5000	2275	1095	1627	6 / 6	1840	1890	1765	1815	3615	3783
	TF / TS550	5500	2475	1295	1827	6 / 6	1770	1810	1695	1735	3654	3822
	TF / TS600	6000	2675	1495	2027	6 / 6	1400	1750	1325	1675	3719	3887
	QF610	6115	2177	997	1512	3 / 3	1480	1490	1405	1415	3961	4130
	QF660	6615	2377	1197	1712	3 / 3	1380	1400	1305	1325	4021	4190
4-Stage full free lift	QF700	7015	2477	1297	1812	3 / 3	1180	1310	1105	1235	4052	4221
	QF745	7465	2627	1447	1962	3 / 3	900	1210	825	1135	4097	4327
	QF790	7915	2777	1597	2112	3 / 3	600	810	525	735	4198	4367

* Standard

Mast Specification (25DT)

Mast Type	Maximum Fork Height (mm)	Overall Height Lowered (mm)	Free Lift Height (mm)		Tilt Angle (Fwd / Bwd)	Load capacity w/o side shift at 500 mm LC (kg)		Load capacity w side shift at 500 mm LC (kg)		Truck Weight Unload (kg)		
			With bkr	With / o bkr		Single Tire	Double Tire	Single Tire	Double Tire	Single Tire	Double Tire	
			25DT	25DT		25DT	25DT	25DT	25DT	25DT	25DT	
2-Stage Limited free lift	V300	3000	2025	155	155	6 / 10	2500	2500	2500	2500	3703	3859
	* V330	3300	2175	155	155	6 / 10	2500	2500	2500	2500	3723	3879
	V350	3500	2275	155	155	6 / 10	2500	2500	2500	2500	3740	3896
	V370	3700	2425	155	155	6 / 10	2500	2500	2425	2500	3762	3918
	V400	4000	2575	155	155	6 / 10	2460	2500	2385	2425	3792	3948
	V430	4300	2725	155	155	6 / 6	2410	2470	2335	2395	3843	4000
	V450	4500	2875	155	155	6 / 6	2350	2430	2275	2355	3865	4022
2-Stage full free lift	V470	4700	2975	155	155	6 / 6	2320	2410	2245	2335	3880	4036
	V500	5000	3125	155	155	6 / 6	2260	2350	2185	2275	3902	4058
	VF290	2900	2025	845	1377	6 / 6	2500	2500	2500	2500	3739	3906
	VF320	3200	2175	995	1527	6 / 6	2500	2500	2500	2500	3772	3939
	TF / TS370	3700	1825	645	1177	6 / 6	2450	2500	2375	2425	3829	3996
	TF / TS400	4000	1925	745	1277	6 / 6	2400	2470	2325	2395	3853	4020
	TF / TS430	4300	2025	845	1377	6 / 6	2340	2410	2265	2335	3871	4038
3-Stage full free lift	TF / TS450	4500	2125	945	1477	6 / 6	2310	2380	2235	2305	3893	4060
	TF / TS470	4700	2175	995	1527	6 / 6	2260	2340	2185	2265	3927	4074
	TF / TS500	5000	2275	1095	1627	6 / 6	2210	2280	2135	2205	3929	4096
	TF / TS550	5500	2475	1295	1827	6 / 6	1600	2210	1525	2135	3968	4135
	TF / TS600	6000	2675	1495	2027	6 / 6	1050	2110	975	2035	4033	4200
	QF610	6115	2177	997	1512	3 / 3	1580	1810	1505	1735	4275	4443
	QF660	6615	2377	1197	1712	3 / 3	1480	1720	1405	1645	4335	4503
4-Stage full free lift	QF700	7015	2477	1297	1812	3 / 3	1230	1630	1155	1555	4365	4534
	QF745	7465	2627	1447	1962	3 / 3	950	1520	875	1445	4411	4580
	QF790	7915	2777	1597	2112	3 / 3	650	910	575	835	4512	4680

* Standard

20/25/30/33DT-7

Mast Specification (30DT)

Mast Type	Maximum Fork Height (mm)	Overall Height Lowered (mm)	Free Lift Height (mm)		Tilt Angle (Fwd / Bwd)	Load capacity w/o side shift at 500 mm LC (kg)		Load capacity w side shift at 500 mm LC (kg)		Truck Weight Unload (kg)		
			With bkr	With / o bkr		Single Tire	Double Tire	Single Tire	Double Tire	Single Tire	Double Tire	
			30DT	30DT		30DT	30DT	30DT	30DT	30DT	30DT	
2-Stage Limited free lift	V300	3000	2040	155	155	6 / 10	2900	2900	2900	2900	4158	4246
	* V330	3300	2190	155	155	6 / 10	2900	2900	2900	2900	4179	4266
	V350	3500	2290	155	155	6 / 10	2900	2900	2900	2900	4196	4284
	V370	3700	2440	155	155	6 / 10	2900	2900	2900	2900	4219	4307
	V400	4000	2590	155	155	6 / 10	2900	2900	2880	2880	4250	4338
	V430	4300	2740	155	155	6 / 6	2900	2900	2800	2850	4303	4391
	V450	4500	2890	155	155	6 / 6	2850	2900	2750	2820	4325	4413
2-Stage full free lift	V470	4700	2990	155	155	6 / 6	2800	2880	2700	2780	4341	4428
	V500	5000	3140	155	155	6 / 6	2750	2820	2650	2720	4363	4451
	VF290	2900	2040	860	1314	6 / 6	2900	2900	2900	2980	4216	4302
	VF320	3200	2190	1010	1464	6 / 6	2900	2900	2900	2980	4251	4337
	TF / TS370	3700	1840	660	1114	6 / 6	2900	2900	2880	2880	4325	4411
	TF / TS400	4000	1940	760	1214	6 / 6	2880	2900	2780	2850	4350	4436
	TF / TS430	4300	2040	860	1314	6 / 6	2830	2880	2730	2780	4372	4458
3-Stage full free lift	TF / TS450	4500	2140	960	1414	6 / 6	2780	2830	2680	2730	4397	4483
	TF / TS470	4700	2190	1010	1464	6 / 6	2750	2790	2650	2690	4411	4497
	TF / TS500	5000	2290	1110	1564	6 / 6	2680	2730	2580	2630	4434	4520
	TF / TS550	5500	2490	1310	1764	6 / 6	2580	2630	2480	2530	4478	4564
	TF / TS600	6000	2690	1510	1964	6 / 6	1880	2530	1780	2430	4548	4634
	QF610	6115	2175	955	1449	3 / 3	1780	2270	1680	2170	4735	4839
	QF660	6615	2375	1195	1649	3 / 3	1670	2160	1570	2060	4794	4899
4-Stage full free lift	QF700	7015	2475	1295	1749	3 / 3	1370	2050	1270	1950	4825	4930
	QF745	7465	2625	1445	1899	3 / 3	1050	1920	950	1820	4871	4975
	QF790	7915	2775	1595	2049	3 / 3	750	1090	650	990	4971	5076

* Standard

Mast Specification (33DT)

Mast Type	Maximum Fork Height (mm)	Overall Height Lowered (mm)	Free Lift Height (mm)		Tilt Angle (Fwd / Bwd)	Load capacity w/o side shift at 500 mm LC (kg)		Load capacity w side shift at 500 mm LC (kg)		Truck Weight Unload (kg)		
			With bkr	With / o bkr		Single Tire	Double Tire	Single Tire	Double Tire	Single Tire	Double Tire	
			33DT	33DT		33DT	33DT	33DT	33DT	33DT	33DT	
2-Stage Limited free lift	V300	2900	2040	155	155	6 / 10	3300	3300	3300	3300	4429	4480
	* V330	3200	2190	155	155	6 / 10	3300	3300	3300	3300	4453	4503
	V350	3400	2290	155	155	6 / 10	3300	3300	3300	3300	4468	4519
	V370	3600	2440	155	155	6 / 10	3300	3300	3200	3300	4492	4543
	V400	3900	2590	155	155	6 / 10	3240	3300	3140	3200	4524	4575
	V430	4200	2740	155	155	6 / 6	3160	3260	3060	3160	4578	4628
	V450	4400	2890	155	155	6 / 6	3110	3210	3010	3110	4601	4652
2-Stage full free lift	V470	4600	2990	155	155	6 / 6	3050	3160	2950	3060	4617	4668
	V500	4900	3140	155	155	6 / 6	3010	3090	2910	2990	4641	4692
	VF290	2900	2040	910	1269	6 / 6	3300	3300	3300	3300	4471	4563
	VF320	3200	2190	1060	1419	6 / 6	3300	3300	3300	3300	4506	4598
	TF / TS370	3700	1890	710	1069	6 / 6	3200	3300	3100	3200	4614	4705
	TF / TS400	4000	1990	810	1169	6 / 6	3110	3220	3010	3120	4636	4727
	TF / TS430	4300	2090	910	1269	6 / 6	3040	3130	2940	3030	4657	4748
3-Stage full free lift	TF / TS450	4500	2190	1010	1369	6 / 6	3000	3090	2900	2990	4678	4770
	TF / TS470	4700	2240	1060	1419	6 / 6	2950	3030	2850	2930	4692	4783
	TF / TS500	5000	2340	1160	1519	6 / 6	2900	2980	2800	2880	4714	4806
	TF / TS550	5500	2540	1360	1719	6 / 6	2000	2870	1900	2770	4758	4850
	TF / TS600	6000	2740	1560	1919	6 / 6	1100	2760	1000	2660	4831	4922
	QF610	6115	2225	1045	1449	3 / 3	1870	2720	1770	2620	4957	5054
	QF660	6615	2425	1245	1649	3 / 3	1780	2590	1680	2490	5017	5114
4-Stage full free lift	QF700	7015	2525	1345	1749	3 / 3	1480	2470	1380	2370	5047	5144
	QF745	7465	2675	1495	1899	3 / 3	1000	2340	900	2240	5090	5186
	QF790	7915	2825	1645	2049	3 / 3	500	1220	400	1120	5193	5290

* Standard

Dimension

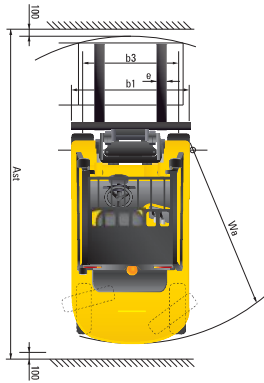
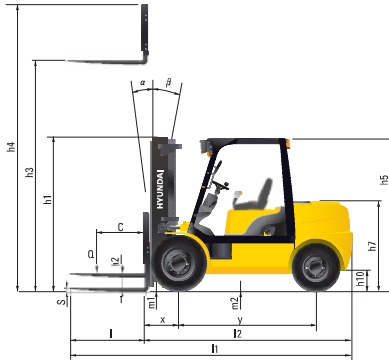

Specification

Identification						
1.1	Manufacturer		Hyundai	Hyundai	Hyundai	Hyundai
1.2	Manufacturer's type designation		20DT-7	25DT-7	30DT-7	33DT-7
1.3	Drive: electric(battery or mains),diesel,petrol,fuel gas,manual		DIESEL	DIESEL	DIESEL	DIESEL
1.4	Type of operation:hand,pedestrian,standing,seated,order-picker		seated	seated	seated	seated
1.5	Load capacity / rated load	kg	2,000	2,500	2,980	3,300
1.6	Load center distance	c mm	500	500	500	500
1.8	Load distance, center of drive axle to fork	x mm	468	468	468	468
1.9	Axle loading, unloaded front/rear	y mm	1,650	1,650	1,700	1,700
Weights						
2.1	Service weight(including battery)	kg	3,417	3,731	4,212	4,494
2.2	Axle loading, loaded front/rear	kg	4,732 / 685	5,460 / 771	6,183 / 929	6,840 / 955
2.3	Axle loading, unloaded front/rear	kg	1,558 / 1,859	1,493 / 2,238	1,631 / 2,581	1,660 / 2,835
Wheels, Chassis						
3.1	Tires:solid rubber, superelactic, pneumatic, polyurethane		Pneumatic	Pneumatic	Pneumatic	Pneumatic
3.2	Tires size, front		7.00-12-12PR	7.00-12-12PR	8.15-15-14PR	8.15-15-14PR
3.3	Tires size, rear		6.50-10-12PR	6.50-10-12PR	6.50-10-12PR	6.50-10-12PR
3.5	Wheels, number front x rear(x=driven wheels)		2x / 2	2x / 2	2x / 2	2x / 2
3.6	Track width, front	mm	965	965	1,005	1,005
3.7	Track width, rear	mm	980	980	980	980
Basic Dimensions						
4.1	Mast / fork carriage tilt forward / backward	degrees	6 / 10	6 / 10	6 / 10	6 / 10
4.2	Lowered mast height	h1 (mm)	2,025	2,025	2,040	2,260
4.3	Free lift	h2 (mm)	155	155	155	155
4.4	Lift height	h3 (mm)	3,005	3,005	3,005	3,305
4.5	Extended mast height	h4 (mm)	4,185	4,185	4,185	4,485
4.7	Overhead load guard(cab) height	h5 (mm)	2,160	2,160	2,180	2,180
4.8	Seat height / standing height	h7 (mm)	1,110	1,110	1,130	1,130
4.12	Coupling height	h10 (mm)	283	283	299	299
4.19	Overall length	l1 (mm)	3,597	3,657	3,742	3,782
4.20	Length to face of forks	l2 (mm)	2,547	2,607	2,692	2,732
4.21	Overall width	b1 (mm)	1,160 / 1,515	1,160 / 1,515	1,230 / 1,515	1,230 / 1,515
4.22	Fork dimensions(hook type)	l / e / s (mm)	1,050x100x45	1,050x100x45	1,050x122x45	1,050x122x45
4.23	Fork carriage ISO 2328, class / type A,B		II / A	II / A	III / A	III / A
4.24	Fork-carriage width	b3 (mm)	1,102	1,102	1,102	1,102
4.31	Ground clearance, loaded, under mast	m1(mm)	130	130	145	145
4.32	Ground clearance, centre of wheelbase	m2(mm)	171	171	189	189
4.33	Aisle width for pallets 1,000x1,200 crossways(LxW)	Ast(mm)	3,928	3,981	4,066	4,102
4.34	Aisle width for pallets 800x1,200 lengthways(WxL)	Ast(mm)	4,128	4,181	4,266	4,302
4.35	Turning radius	Wa(mm)	2,260	2,313	2,398	2,463
Performance Data						
5.1	Travel speed, unloaded	km/h	20.5	20.5	21.5	21.4
5.2	Lift speed, loaded/ unloaded	mm/s	600 / 610	590 / 600	490 / 500	480 / 500
5.3	Lowering speed, loaded/unloaded	mm/s	500 / 450	500 / 450	500 / 450	500 / 450
5.5	Drawbar pull, loaded	kg	2,118	2,134	2,024	2,031
5.7	Gradient performance, loaded/ unloaded	%	37.3	32.2	26.0	24.0
5.10	Service brake		Foot	Foot	Foot	Foot
Engine						
6.1	Engine manufacturer / type		HYUNDAI WIA / WC30D	HYUNDAI WIA / WC30D	HYUNDAI WIA / WC30D	HYUNDAI WIA / WC30D
6.2	Rated output	ps/rpm	60 / 2,500	60 / 2,500	60 / 2,500	60 / 2,500
6.3	Maximum torque	kgf.m/rpm	18.7 / 1,800	18.7 / 1,800	18.7 / 1,800	18.7 / 1,800
6.4	No. of cylinder / cubic capacity	E/acc	4 / 2,957	4 / 2,957	4 / 2,957	4 / 2,957
6.5	Oil volume	ℓ	54	54	54	54
Other Details						
8.2	Operating pressure(system / attach)	kgf/cm ²	200 / 165	200 / 165	200 / 165	200 / 165
	Attach oil volume (Max.)	ℓ/min	54	54	54	54

20/25/30/33DT-7

Load Capacity

20DT-7

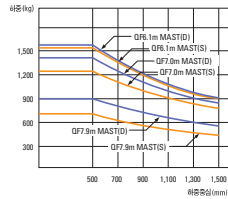
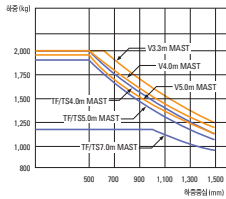

25DT-7

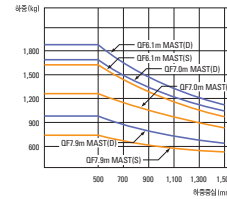
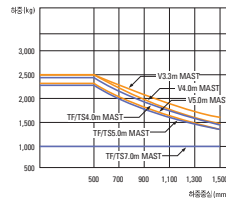

30DT-7

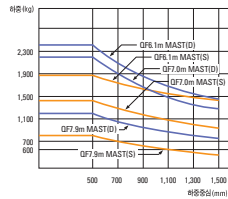
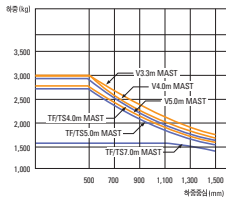

33DT-7

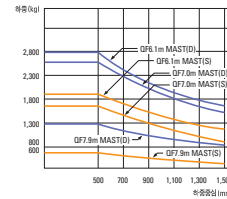
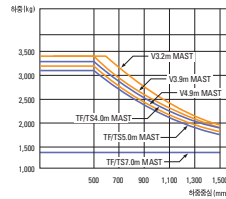

Various Attachments

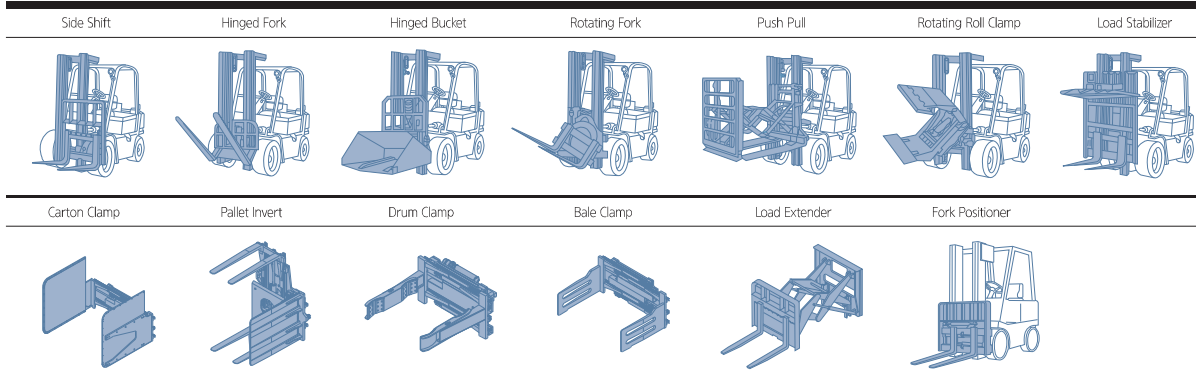

Optional Items

- Cabin & Heater
- Sideshift, Fork Positioner
- Integrated Sideshift, Integrated Sideshift with Fork Positioner (Sync)
- Fork (mm)
20/25DT-7 900 / 1,000 / 1,200 / 1,350 / 1,500 / 1,650 / 1,800 (1,050 STD)
30/33DT-7 900 / 1,150 / 1,200 / 1,350 / 1,500 / 1,650 / 1,800 / 2,400 (1,050 STD)
- Overshoe(mm)
20/25DT-7 1,300 / 1,500 / 1,700 / 1,800
30/33DT 1,500 / 1,700 / 1,800
- Tilting
6° / 6°, 3° / 3°

- Tire
Solid, Non-marking
Double tire (Front)
- Exhaust (Horizontal)
- Master S/W
- MCV
- 4-SPOOL
- MAST
2-Stage full free lift
3-Stage full free lift
4-Stage full free lift

- Pre Cleaner
- Seat
Grammer
(Arm rest, Buckle sw, Seat belt interlock)
- OPSS(Travel, Travel+Mast)
- Load Weight Indicator